



D8x D16x DELUXE



Available with Navigator, Saturn or KPX keypad options

D8XD / D16XD ALARM CONTROL PANEL

Deluxe edition with expanded AUX outputs, Voice alarms, Voice prompts, enhanced modem, Real time clock.

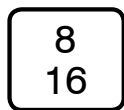

8 or 16
Hardwired or
Wireless zones



Auto-Time
Automation



Up to 8 AUX
Outputs

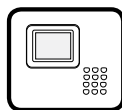

Various
Keypad
Options



Operation by
Smartphone /
Internet



Operation by
Telephone



Voice Alarms
& Prompts



Access
Control
onboard



Powerful
Wireless
Options

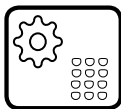

Easy
Programming
via Keypad



Fast
Programming
via PC



Free
NessComms
Installer Software



On-Site
Programming
via PD Tool

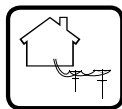

Landline Dialler
for Back To Base
or Voice Dialler
Monitoring

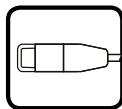

Adjustable
Vibration Inputs
on all Zones



C-BUS
Compatible
using Ness
MiniCentral

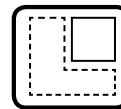

Area
Partitioning



Dual Voltage
17VAC & 20VDC



CORPORATION

Innovative Electronic Solutions

www.ness.com.au

National Customer Service Centre
Ph: 1300 551 991
techsupport@ness.com.au



**D8X/D16X DELUXE
INSTALLATION & PROGRAMMING MANUAL**

Document Part No: 890-017
Rev 2.5 March 2023
For use with Ness D8x/D16x DELUXE control panels V8.0 and later.

This manual can also be used for previous versions of D8x/D16x panels however some of the programming options covered are available only in V8.0 and later.

Refer to installation manual 890-007 for D8x/D16x V7.8 and earlier.

WARNINGS & NOTICES

Ness Corporation manufacturing processes are accredited to ISO9001 quality standards and all possible care and diligence has been applied during manufacture to ensure the reliable operation of this product. However there are various external factors that may impede or restrict the operation of this product in accordance with the product's specification.

These factors include, but are not limited to:

1. Erratic or reduced radio range (if radio accessories are installed). Ness radio products are sophisticated low power devices, however the presence of in-band radio signals, high power transmissions or interference caused by electrical appliances such as Mains Inverters, Wireless Routers, Cordless Phones, Computers, TVs and other electronic devices may reduce radio range performance. While such occurrences are unusual, they are possible. In this case it may be necessary to either increase the physical separation between the Ness receiver and other devices or if possible change the radio frequency or channel of the other devices.
2. Unauthorised tampering, physical damage, electrical interruptions such as mains failure, electrical spikes or lightning.
3. Solar power inverters are a known source of electrical interference. Please ensure that this product and all associated cabling is installed at least 3 metres away from a solar power inverter and its cabling.

WARNING: Installation and maintenance to be performed only by qualified service personnel.

CAUTION: Risk of explosion if battery is replaced by an incorrect type. Dispose of used batteries in accordance with local regulations.

ADSL NOTICE: ADSL broadband data can interfere with the operation of your alarm dialler. It is recommended that a quality ADSL filter be installed as per the filter manufacturer's guidelines in premises with an alarm dialler installed.

All rights reserved. No part of this publication may be reproduced, transmitted or stored in a retrieval system in any form or by any means, electronic, mechanical, photocopying, recording, or otherwise, without the prior written permission of Ness.

Ness reserves the right to make changes to features and specifications at any time without prior notification in the interest of ongoing product development and improvement.

© 2023 Ness Corporation Pty Ltd ABN 28 069 984 372

PRODUCT FEATURES.....	4	Line Fault Monitor	49
NessComms Features	5	Remote access options	50–51
Installation notes	6	Required Rings	52
Inputs and outputs	7		
		No Memory Warning zones	52
CONNECTION DIAGRAM	8–9	FACTORY DEFAULTS	
Keypad	10	Clear Radio Devices.....	53
		Clear Memory.....	53
OPERATION		Clear Panel Options	53
Operation Summary	11	Clear User Codes.....	53
HOW TO PROGRAM		Output Expander options.....	54–56
Quick start Programming.....	12	AUX OUTPUTS	
How to enter Program Mode	13	Aux1 output options.....	58–59
How to program using NessPD.....	13	Aux2 output options.....	60–61
		Aux3 output options.....	62–63
		Aux4 output options.....	64–65
		Aux5–8 output options.....	66–67
SPECIAL FUNCTIONS			
Send test report	12	Alarm/Fire/Chirp Siren Volume	67
Siren test	12	Enable/Disable hardwire zones	68
Panel reset	12	KPX Keypad options	68
Display software version.....	12	End Of Line Resistor options	68
		AUTOTIME OPTIONS	
GENERAL OPTIONS		AutoTime description and examples	69
User Codes	14, 15	RealTime Clock programming.....	70
Timers.....	16	AutoTime programming.....	70–71
Vibration Sensitivity.....	17		
Zone Assignment.....	18, 19	RADIO OPTIONS	
Definitions. Day Zones, Temp Day Zones, Home	20	Signal strength test.....	72
Zone To Output Mapping.....	22–23	Ness Radio Interface.....	72
Various Options.....	24–25	RADIO DEVICE PROGRAMMING	73
Tamper/Keypad Panic Output Mapping	26	RADIO KEY PROGRAMMING	74
System Operation Shortcuts.....	27		
Home mode output mapping	28	Serial Output options	75
Day mode output mapping.....	28	ACCESS CONTROL OPTIONS	
Miscellaneous Options	29–30	PROGRAMMING ACCESS CARDS	76
Zone Supervision options.....	31–33	Access Control options.....	77–81
Misc. options	35–37	Weigand Reader wiring diagram	82
		REMOTE OPERATION	
DIALLER OPTIONS		Monitoring operation.....	83
TELEPHONE NUMBERS	38–39	System Name programming	84
Account Numbers	38	Voice Message Library.....	84
Report zone alarms.....	40	Remote operation by telephone	85
Report zone restorals.....	40		
Report multiple zone alarms.....	40	PROGRAMMING OPTIONS SUMMARY	86–91
Account No.2 zones.....	40	D8x/D16x Product List	92
Report Miscellaneous alarms	41	Specifications and approvals.....	92
Report Miscellaneous Restorals	41	Release Notes.....	93
Test Call options.....	42	Installation Record	95
Dialler format options.....	43–44		
CONTACT ID REPORTING CODES	43		
Dialling options	45		
Area1, Area2 open/close reports.....	46		
Siren Chirp, Flash options	46		
Other reports.....	47		
Enable Test Calls.....	48		
Mains Report Delay.....	48		
Listen-in to dialler.....	48		
Swinger Shutdown.....	49		

OPTIONAL PRODUCT



Ness iComms
Ness aComms

Ness iComms and aComms apps for mobile control of your D8x/ 16x control panel from home, office, anywhere in the world using your iPhone/iPad or Android device.

- ARM, DISARM
- VIEW ZONE STATUS
- EMERGENCY ALARMS
- CONTROL THE PANEL OUTPUTS (D8X/D16X V7.8+)

Requirements:

D8x/D16x V5.6 or later (V7.8 or later to operate panel outputs).

Optional 101-244 Ethernet adapter required.

iPhone/iPad/Smartphone not included.

iComms and aComms are third party apps which are endorsed by Ness without tech support.

Emergency alarms must be enabled in the control panel to be available in iComms and aComms.

What's New in D8x/D16x Deluxe (v8)

- New PCB layout
- Added modem chip, use any modem in 300baud mode
- Voice alarms and voice prompts using a preset voice message library
- Real time clock onboard
- New connector for the Serial port, now 4 pin
- New connector for the Listen-in header
- Dual 17VAC/20VDC power input
- Tamper/Prog link moved to corner of pcb for better accessibility

D8x/D16x All Features

- 8 or 16 alarm zones.
- Supports up to 3 mixed keypads (Navigator/Saturn/LCD) or 4 Navigator keypads
- 56 user codes can be programmed to operate by keypad PIN, radio key or access card.
- Optional NESS RADIO INTERFACE for fully integrated wireless security.
- Programmable TWO AREA PARTITIONING can split the panel into two independent areas plus a common area.
- REAL TIME CLOCK with AUTOTIME features - auto arm/disarm, auto aux outputs, time based user control.
- 3 Door ACCESS CONTROLLER onboard with support for Weigand prox or fingerprint readers.
- Supports control via INTERNET using Ness iComms/aComms iPhone/iPad and Android apps and optional ethernet adapter.
- Voice alarm reports & Voice prompts for remote telephone operation.
- Home Mode allows partial arming, (eg, perimeter security overnight).
- Day Mode feature allows daytime monitoring of fire doors, coolrooms etc.
- Temporary Day Zone feature allows easy enabling/disabling of Day Mode.
- Keypad Panic and Duress feature.
- Two button arming feature.
- Fire Alarm feature with different siren tones.
- Highly flexible zone to output mapping.
- ONBOARD VIBRATION SENSOR ANALYSER with programmable sensitivity. Use with Nessensor™ vibration sensors.
- MULTIPLE PROGRAMMABLE EOL resistor values from 0k to 22k (2k2 resistors supplied).
- Siren chirp and strobe flash on arming with radio key.
- Quiet chirps option on arm/disarm by radio key.
- True DYNAMIC BATTERY TEST actively tests the battery under load every hour and every time a keypad code is entered.
- PROGRAMMABLE AUXILIARY outputs.
- ENHANCED SERIAL DATA input/output via RS232.
- AUTOMATIC RESET FUSES.
- Programmable Reset Output lockout.
- 30 event memory from KPX and Saturn keypads. 80 event memory can be accessed using Navigator keypad or NessComms™.
- Standard defaults to suit most applications.
- Easy programming by keypad or NessComms™ software.
- New modem chip allows common modems to be used for upload/download in 300baud mode.
- All programming data is permanently stored in a non-volatile memory.
- All inputs and outputs are heavily protected against lightning and high voltage supply transients.
- High efficiency DC power supply.

LANDLINE DIALLER

- Remote control of outputs via telephone with voice prompts.
- Contact ID Format for central station monitoring.
- Voice alarm reporting option.
- Phone line monitoring (activates output).
- Dialler 'Listen in' option for installers.
- Auto Test calls.
- Pulse or DTMF dialling & true dial tone detection.
- Hex programmable client codes as required by some central stations.



FREE SOFTWARE

NESSCOMMS

Powerful PC-based programming & operation software

- Fast and easy installation programming
- Download system logs, including extended D8x/D16x logs not accessible by keypad - up to 80 events
- Database stores hundreds of clients
- All relevant control panel manuals are installed with NessComms
- Free For Trade users

The preferred programming tool for many installers, NessComms makes control panel programming as simple as ticking the boxes.

NessComms operates by direct connect to the control panel's serial port.

Optional 450-246 serial cable is required.

D8X / D16X DELUXE

DIRECT CONNECT On-Site

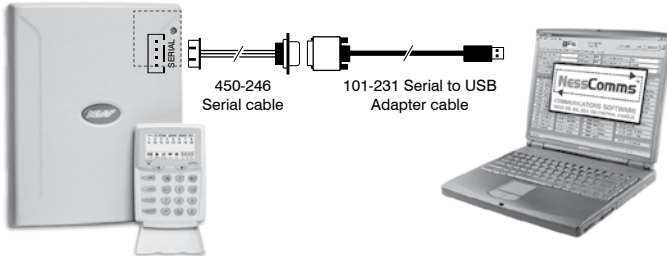

Note:

D8x/D16x Deluxe (v8 and later) uses 450-246 serial cable (4 pin)
Previous versions of D8x/D16x use 450-185 RS232 cable (3 pin)



OPTIONAL PRODUCT



To Clipsal C-Bus



MINICENTRAL C-BUS

Part No. 106-125

The Ness MiniCENTRAL C-Bus interface combined with a Ness D8x or D16x control panel gives you full two-way C-Bus control and all the features and benefits of a powerful alarm panel.

- Fully Clipsal approved C-Bus Enabled Product.
- Controls up to 255 individual C-Bus lights or outputs. Includes full dimming, On/Off and toggle commands.
- True 2 way communications on the C-Bus network.
- Connects directly onto C-Bus without the need for additional hardware such as a PCI Interface.
- Many D16X events or status changes can control modules on the C-Bus.
- C-Bus Trigger Control and Enable Control.
- C-Bus events can control the D8x/D16x.
- Multiple onboard SERIAL repeater ports means the D8x/D16x panel can also connect to other serial devices while connected to MiniCENTRAL.



OPTIONAL PRODUCT

NESS PD

Portable Download Tool

Part No. 106-017

Ness PD is the fast, easy and simple way to copy programming options from one control panel to another in the field - all without a computer.

Ness PD copies and loads data from panel to panel using the READER header on D8x and D16x panels.

- Stores separate data for one D8x and one D16x.
- Ideal for programming service panels.
- Use Ness PD to store your default programming for even faster commissioning on site.

Requires D8x/D16x V7.4 or later. Not compatible with 106-009 D16x C-Bus panel.

How to use the NessPD, see page 13.

ESD WARNING

(Electrostatic Discharge).

Once properly installed, Ness control panels are well protected from ESD. However, take note of the following precautions during installation.

The human body can generate static electricity when it is insulated from earth - for instance by walking over carpet.

ESD occurs (and a small shock is sometimes felt) if an earthed metal object is then touched.

The installer should be aware that if he generates static electricity while installing the panel and then discharges this static electricity into the internal components on the main D8/D16 circuit board or the keypad board, then ESD damage may occur.

The circuit board should not be unwrapped until it is actually ready to be installed.

Methods to avoid electrostatic build-up.

1. Use a foot strap, a wrist strap, or a grounding mat. The aim is to connect the body to earth to discharge static before it builds up. The connection is a high resistance for personnel safety.
2. If the above is not available, then it is advisable to wear clothing that will minimise the build-up of static.
3. Handle circuit boards by the edges. Avoid touching any components on the board as the integrated circuits, in particular, are not guaranteed by their manufacturers to be safe from ESD.
4. To minimise the build-up of static, avoid walking around as much as possible while working on the installation.
5. Touch an earthed object to discharge any static before working on the installation.

INSTALLATION PROCEDURES

The main panel housing and keypad/s should be installed within areas that are protected by motion sensors or reed switches. A linen closet or cupboard are good examples as these are generally located in the centre of the premises. Installing in ceiling spaces or other areas where extremes of temperature may be encountered is not advised.

Positioning of the movement detectors should be considered as the incorrect position may cause unwanted alarms. Refer to the motion sensors' installation instructions.

1. Remove the lid and the battery from the base.
2. Securely mount the rear panel housing in a secure location.
3. Run all cabling needed for the installation.
4. Insert the red PCB stand-offs in the housing and then plug the circuit board onto the stand-offs. See the ESD Warning on this page.
5. Wire the sensors, sirens and accessories to the main board terminal blocks as per the wiring instructions shown in this installation manual.
6. Fit the battery into the housing but **DO NOT CONNECT** the battery yet.
7. Insert the panel tamper bracket leads as shown below.
8. Power up as described below.
9. Close the lid and program the panel as required.

POWER-UP PROCEDURE

To enter **INSTALLER PROGRAM MODE** the first time, power-up with the **PROG/TAMP** link **OFF**. If the **PROG/TAMP** link is **ON** and any other 24hr zones are unsealed on power-up the panel will immediately go into alarm - reset the alarm via keypad or remove power to stop the alarm.

1. **CONNECT THE BATTERY FIRST.** Observe correct polarity.
 - a) The heartbeat LED will flash continuously to indicate correct operation.
 - b) The Current Limiting Globes should be **OFF**. If the Globes are glowing, the battery connection is reversed. Immediately disconnect the battery and check the polarity of the battery leads.

If the heartbeat LED does not flash steadily or cycles off intermittently there may be a problem with the initialisation of the onboard memory. **To remedy, in Installer Program Mode press P95E, P97E & P98E to erase all programming and reload factory defaults.** Then remove power by briefly removing one of the battery leads then re-connect. The heartbeat LED should now be flashing continuously, proceed to step 2.

2. **TURN ON THE EXTERNAL POWER SUPPLY.** The Current Limiting Globes may glow slightly to indicate that the battery is charging correctly.

NOTE:

Your panel has a dual 17VAC/20VDC power input. Please use the correct power supply as shown on page 8

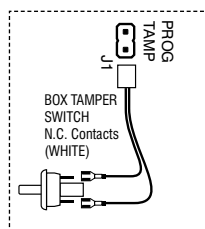
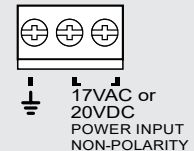

Insert the white N/C tamper switch

Backup battery holder.
Suits up to 12V 7Ah battery.

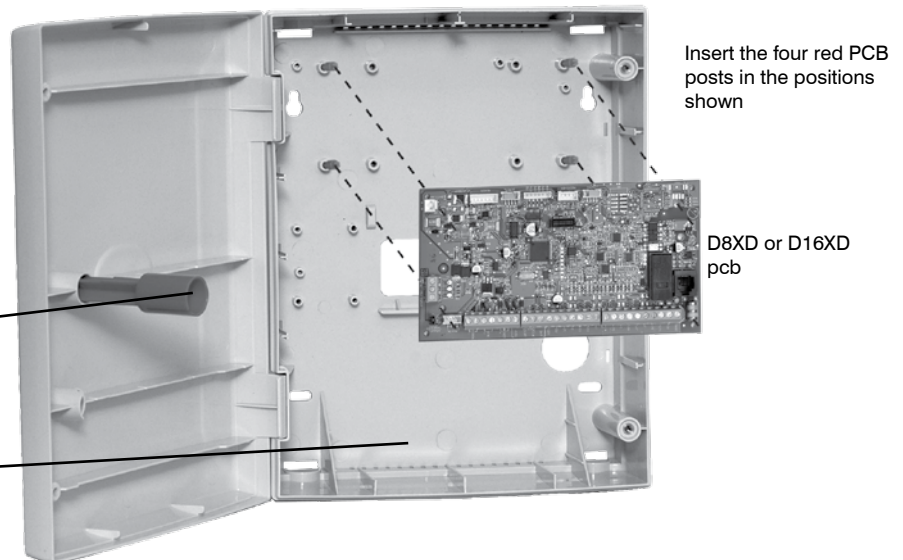

INPUTS

MONITORED ZONES

The Ness D8x and D16x have 8 or 16 fully programmable zone inputs. (Monitored by end of line resistor). Also, 1 x 24 hour External TAMP input. (Monitored by end of line resistor). 1 x 24 hour Box Tamper input. (Normally Closed input. Resistor is not required).

END OF LINE RESISTOR

Each zone input must be terminated with an end of line (EOL) resistor unless the zone is disabled by option P125E.

The default EOL resistor value is 2.2k (2200 Ohms). The EOL value is fully programmable. Available options are 0k (closed circuit), 1k, 1.5k, 2.2k, 3.3k, 3.9k, 4.7k, 5.6k, 6.8k, 8.2k, 10k, 12k and 22k. See programming option P129E.

TAMP – TAMPER INPUT

The TAMP input must also be sealed with an end of line resistor. This input is always a 24hr input. The EOL value programed by option p129E also applies to the TAMP input.

POWER INPUT TERMINALS

These terminals are for the connection of the external power supply. Your panel has a dual 17VAC/20VDC power input. Please use the correct power supply as shown on page 8.

EARTH (Functional Earth, not a safety Earth)

Connect a good earth to this terminal to help protect against damage from lightning strikes and static.

BATTERY

These terminals are for the connection of a sealed lead-acid rechargeable 12Volt battery. Charge current is limited to 350mA. The charge voltage is factory preset at 13.8V. Note: A 12 Volt sealed lead acid rechargeable battery must be connected for correct panel operation and to ensure the Siren, Strobe and Reset outputs operate correctly.

The panel will shut down if battery voltage is below 11V and mains power is off.

Observe correct polarity when connecting the battery.

(Ness Part Number BAT210 12V 7Ah battery)

CURRENT LIMITING

The current limiting globes serve to regulate battery charging current. When the battery is fully charged the globes will not glow. The globes will glow slightly when recharging the battery after a short power outage. If the globes glow very brightly the battery is drawing excessive current and may be faulty, or the battery is connected in reverse. Check the connections or connect a charged battery.

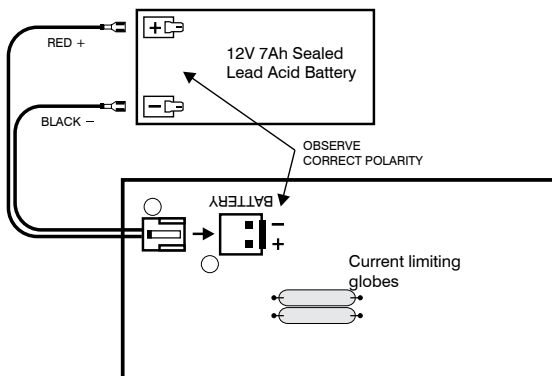

OUTPUT FUSING. The 12V outputs, Siren, Reset and Strobe outputs are protected by Automatic Reset electronic fuses. These outputs will automatically reset once the overload is removed.

OUTPUTS

12 VOLT OUTPUT

A regulated 13.8 VDC output is available to power detectors and other equipment. This output is available from two sets of terminals marked +12V and 0V. This output is protected by an Automatic Reset fuse.

A maximum load of 500mA may be connected to these terminals.

SIREN

The on-board siren driver will drive a maximum of 3 x 8 ohm horn speakers (Ness Part No. NOI110 or 100-171 Internal Siren). The will reset at the end of siren time (P29E) or whenever the panel is reset, whichever comes first.

This output is protected by an Automatic Reset fuse.

STR

A latched 12VDC output for connecting strobe lights.

This output will reset after 72 hours (3 days) or when the panel is disarmed. (D8/D16 versions prior to V4.5 allow indefinite strobe operation, until the panel is reset).

A maximum of 2 x 1 Watt Strobes (Ness Part No. NOI300) can be connected to this output.

This output is protected by an Automatic Reset fuse.

RESET

A 12V DC output for connecting Ness sirens, piezo sirens or relays, etc. This output will reset at the end of siren time (P29E) or whenever the panel is reset, whichever comes first.

A maximum of 3 x 12V piezo screamers (Ness Part No. 100-238, 100-004) or 2 X Ness Piezo (Part No 100-172) can be connected to this output.

This output is protected by an Automatic Reset fuse.

AUX HEADER

The Aux1 to Aux4 outputs are open collector outputs (switch negative) which can supply a maximum of 100mA. Each Aux output can be programmed to perform several different functions. The header also provides a 12V DC output, max. draw 100mA.

RS232 SERIAL PORT (4 PIN)

Two way RS232 serial port for interfacing to a PC or external automation products. The serial data is 9600 baud, 8 data bits, no parity, 1 stop bit. Developer's kit available on request.

PROG/TAMP – PROGRAM LINK & INTERNAL TAMPER INPUT

The PROG/TAMP link appears on the two pin J1 header.

The PROG/TAMP link has two purposes:

- To enter Installer Program Mode on initial power up.** Power-up with the PROG link OFF. The PROG link (or Box Tamper lead) must be ON in operating mode.
- Box Tamper.** When used with the Internal Tamper Lead (supplied), PROG/TAMP serves as the 24hr tamper input for the panel's internal tamper switch.

Replace the PROG Link with the Box Tamper Lead. Connect the Internal Tamper Lead spade terminals directly to the terminals of the internal tamper switch (supplied). An end-of-line resistor is NOT required on this input.

When PROG/TAMP is used for Internal Tamper, powering up with the panel's cover open will enter Installer Program Mode.

SIREN LOAD. A maximum output of 2.0A continuous is available from the SIREN and RESET outputs and 200mA from the STR output.

Recommended maximum power load:

- 3 x Horn speakers (SIREN output)
- 2 x Strobe lights (STR output)
- 2 x Ness Internal Sirens (100-172) (RESET output)

Note: (This assumes no more than 500mA is being drawn from the 12V device outputs).

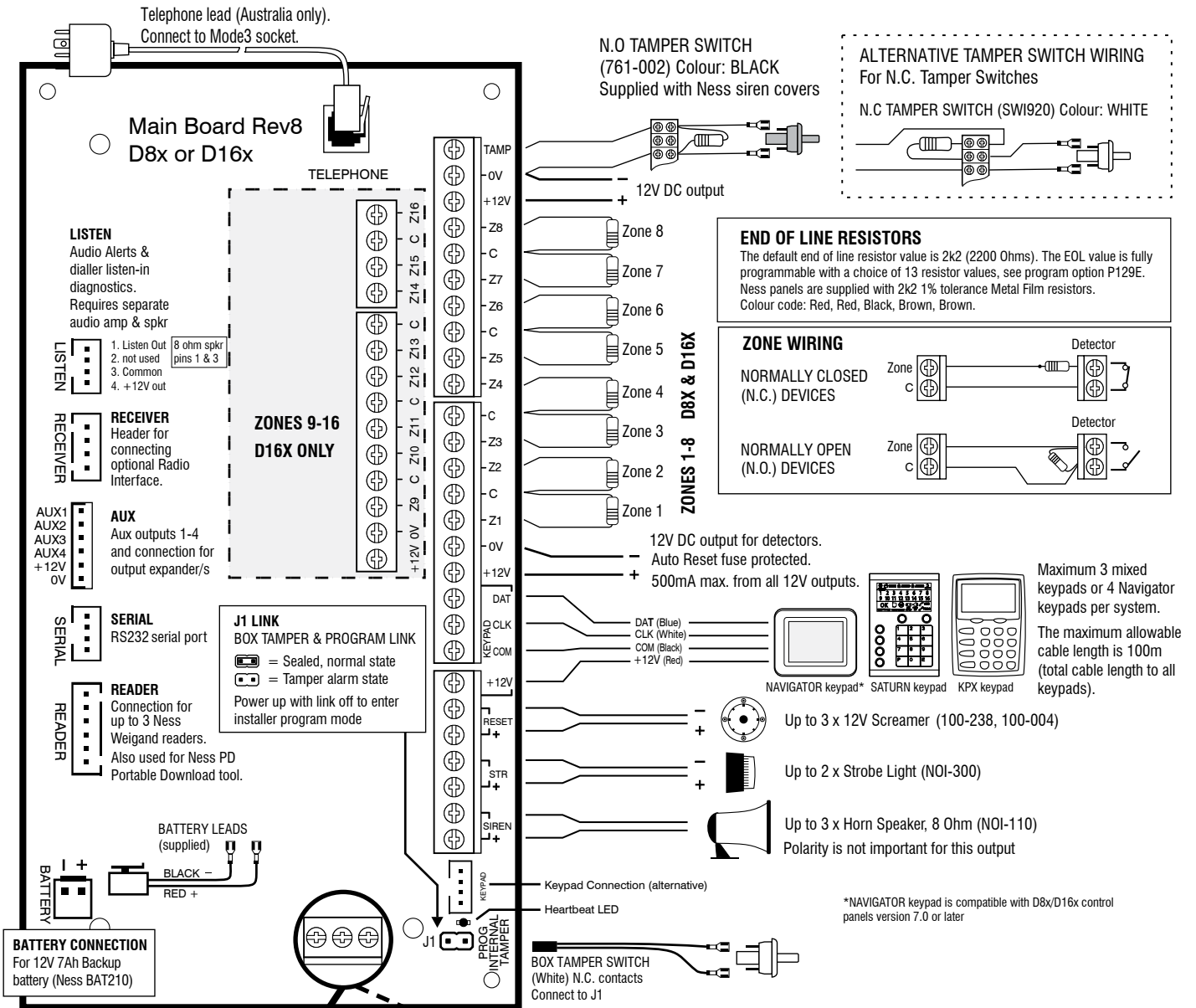

DUAL VOLTAGE POWER INPUT
17VAC or 20VDC

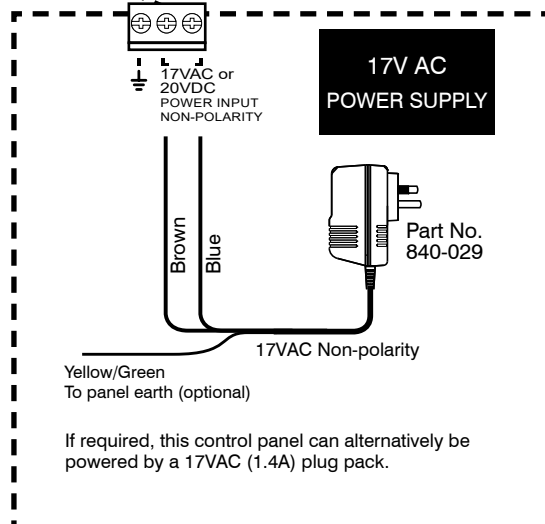
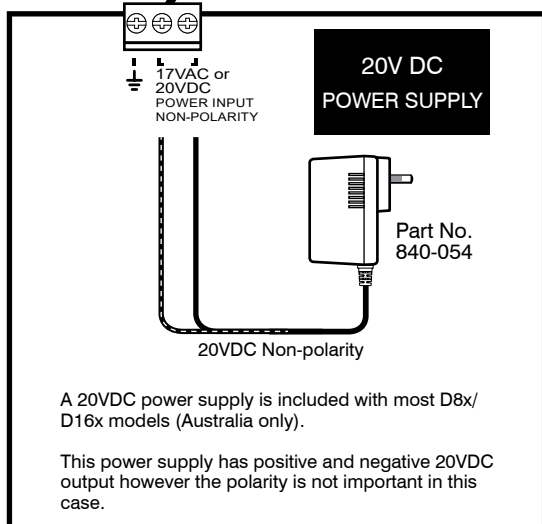

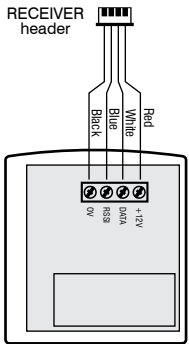
Optional Accessories for D8 & D16

100-200
Ness Radio Interface.

*The Weigand Interface and Ness PD both connect to the READER header. Weigand Interface may be temporarily disconnected to use the Ness PD.

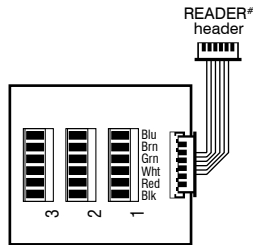

106-012 **Weigand Interface.**
Provides connection for up to 3 addressable Weigand Readers (Ness 101-014). See page 82.

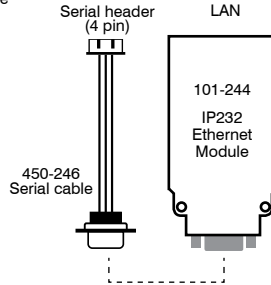

101-244
Internet interface.
Provides internet connectivity for use with Ness G1 Z-Wave gateway and third party apps such as iComms & aComms.

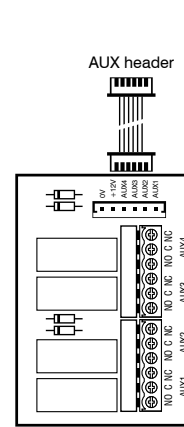

106-013 **Relay Board.**
Provides 4 relay outputs suitable for switching low voltage accessories.

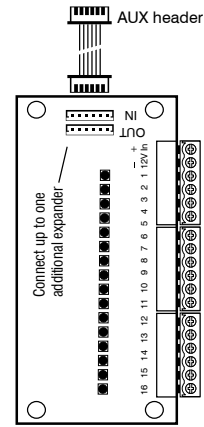

106-011 **Output Expander.**
Provides 16 programmable open collector outputs. See page 54.

The Relay Board and the Output Expander Board connect to the Aux header but not at the same time.

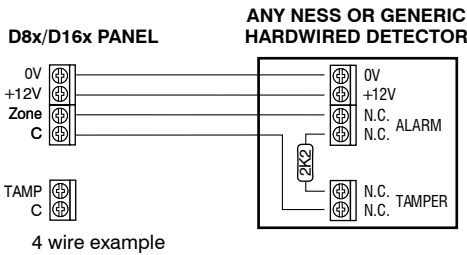
Generic Detector Wiring Examples

4 wire example

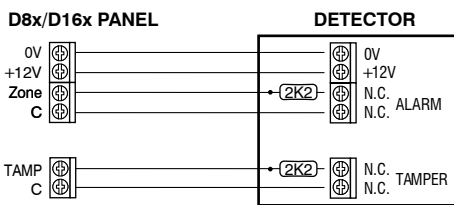

6 wire example with 24hr Tamper

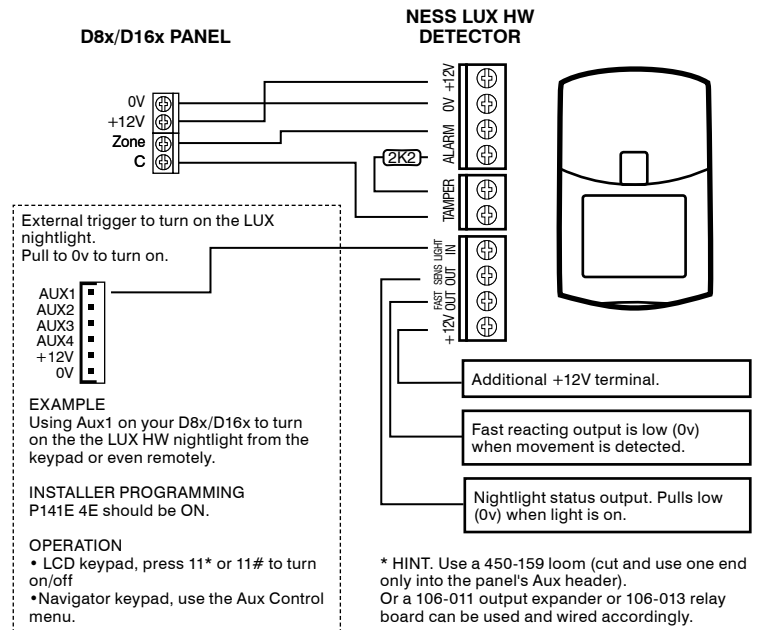
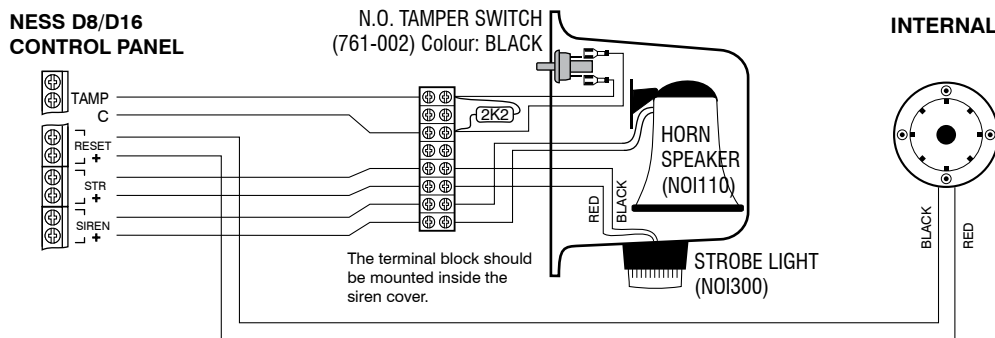
LUX HW Detector Wiring

Siren Wiring Examples

KEYPAD



The instructions on this page relate to Ness KPX+ and Saturn+ keypads.

Refer to the Ness Navigator user's manual for operating instructions specific to the Navigator Touch Screen keypad.

KEYPAD BEEPS

BEEPS	MEANING
♪ 1 BEEP	Any key press.
♪♪♪ 3 BEEPS	Valid Command.
♪— 1 LONG BEEP	Error.
♪..10.. 10 BEEPS	Mains Power is off or Panel Battery is low or A Radio Device has sent a low battery signal or Telephone Line Fail has been detected.
♪...♪...♪... Constant SLOW beeps	An AutoTime action is due to begin.
♪♪♪ Constant FAST beeps	An AutoTime action will begin in <i>one minute</i> .

KEYPAD ADJUSTMENTS

Keypad settings are stored in the keypad - adjust each keypad individually.

To Adjust Key Beep Volume

Press and hold the **P** key. Release when the desired volume is reached.

To Adjust Chime Volume

Press and hold the **0** key. Release when the desired volume is reached.

To Adjust Backlighting

Press and hold the **9** key to adjust the brightness of the LCD and keys backlighting. Release when the desired brightness is reached.





DISPLAY	OFF	ON	FLASHING
ZONES 1-8 (or 1-16)	Zone is sealed.	Zone is unsealed.	Zone is in alarm.
OK TO ARM	Zone/s are unsealed OR Power fault OR Panel is armed	Ready to Arm	
ARMED	Panel is disarmed, or Area 1 is disarmed, if using Areas.	Panel is armed, or Area 1 is armed, if using Areas.	
ARMED	Area 2 is disarmed.	Area 2 is armed if using Areas.	
HOME	Home Mode is disarmed.	Panel is armed in Home Mode.	Day Mode enabled, (see page 20).
MEM	Normal.	Memory mode selected.	New alarm/s in memory.
	Normal.	Receiving a radio signal. (If radio fitted.)	A Radio Key or other radio device has low battery.
TAMPER	Normal.		Internal Tamper: Double Flash with long pause. External Tamper: Steady flash.
EXCLUDE	Normal.		Zone/s are Excluded.
LOW	Normal.		The backup battery is low.
OFF	Normal.		Mains power is off.
CELL *	Normal.	Dialler is on line.	Phone line fault or failure to communicate.
PROG	Normal.	User Program Mode.	Installer Program Mode.

* This control panel has a PSTN phone line (landline) dialler. The CELL icon indicates phone line conditions.

KEYPAD DISPLAY INDICATORS IN MEMORY MODE

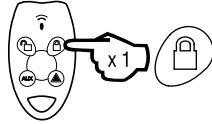
KEYPAD ICON	MEMORY EVENT
Zone numbers 1-8 or 1-16	Zone alarm
(no icons displayed)	Panel Disarmed
ARMED	Panel Armed (or Area 1 Armed)
ARM2	Area 2 Armed
MAINS	Mains power failure
BATTERY	Low Battery
TAMPER + 1	Internal Tamper alarm
TAMPER + 2	External Tamper alarm
EXCLUDE + 1	Panic alarm
EXCLUDE + 2	Medical alarm
EXCLUDE + 3	Fire alarm
CELL	Telephone line fail
RADIO, EXCLUDE	Radio Key Panic alarm
RADIO, BATTERY, ZONE	Radio Device battery low, (Device number is indicated by zone lights)
RADIO, BATTERY, ARM	Radio Key battery low, (Radio Key number is NOT indicated)
RADIO, TAMPER, ZONE	Radio Device tamper alarm (Device number is indicated by zone lights)
RADIO, HOME, ZONE	Radio Supervision alarm (Device number is indicated by zone lights)
HOME, ZONE	Wired Zone Supervision alarm (Zone number is indicated by zone lights)

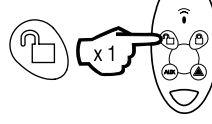
OPERATION SUMMARY

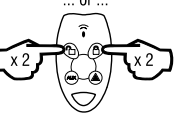
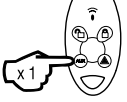
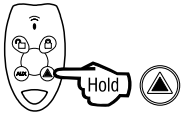
OPERATION	by KEYPAD	by RADIO KEY	by ACCESS CARD or FOB
to ARM The panel must initially be disarmed.	Press ARM + E (If the Arming Shortcut is enabled, P62E 5E) or press ARM + [User Code] + E or press [User Code] + E (If Code Only Arming has been enabled for that user code. Extra Option 4E)	 <p>Press the ON button once.</p>	 <p>Present a Card or Fob twice. (if P301E 2E is on).</p>  <p>Or, present a Card or Fob once + press button. (if P301E 3E is on).</p>
to DISARM To disarm and/or reset alarms.	Press [User Code] + E	 <p>Press the OFF button once.*</p>	 <p>Present a Card or Fob once. (if P301E 4E is on).</p>
to arm HOME MODE Area1 must initially be disarmed. Home Mode can be used if the panel is fully disarmed or if only Area2 is armed, see page 20 for more information.	Press MONITOR + E (If the Home Shortcut is enabled, P62E 3E) or press MONITOR + [User Code] + E	<p>... Or ...</p>  <p>Press either the OFF button or the ON button twice within 4 seconds. (P69E 5E must be on).</p>  <p>Or press the AUX button once. (If P120E 3E is on). RK4 radio key only.</p> <p>Radio Key Home Arm chirps can be enabled by P120E 2E. Radio Key Home Arm strobe flash can be enabled by P64E 6E, (off by default).</p>	
PANIC alarm	Press *# keys together or press *# + [User Code] + E or press *# + E (If Keypad Panic Shortcut is enabled, P62E 4E)	 <p>Press and hold the PANIC button for at least 4 sec. If P68E 1E Double Press Radio Panic is enabled, press and hold twice for 4 sec.</p>	
KEYPAD DUESS Keypad Duress allows the user to send a silent duress report while disarming, (if the system is being monitored by a central station).	Press [5, 6, 8 or 9] + [User Code] + E Add one these digits in front of a user code when disarming. This sequence will disarm the panel and send a Duress report by dialler to the central station. (Report Keypad Duress must be enabled, P75E 1E)		
EXCLUDE ZONES EXCLUDE + E can only be used when the panel is disarmed. EXCLUDE + CODE + E can be used anytime.	Press EXCLUDE + E (If the Exclude Shortcut is enabled, P62E 2E) then [Zone No.] + E [Zone No.] + E (Enter the zone number/s to be excluded.) then press E to exit Exclude mode The Exclude light flashes constantly while zones are excluded. Excluded zones are automatically Included next time the panel is disarmed.		
OPERATE AUX OUTPUTS The AUX outputs must be enabled for operation by keypad. See P141E 4E, P142E 4E, P143E 4E, P144E 4E.	Press 1 1 *# to turn ON or PULSE AUX1 . Press 1 1 # to turn OFF. Press 2 2 *# to turn ON or PULSE AUX2 . Press 2 2 # to turn OFF. Press 3 3 *# to turn ON or PULSE AUX3 . Press 3 3 # to turn OFF. Press 4 4 *# to turn ON or PULSE AUX4 . Press 4 4 # to turn OFF.		

* If a user code is assigned to a radio key and has Extra Option 4E enabled, (Code Only arming), then pressing OFF toggles the panel arm/disarm state.

TEMPORARY DAY ZONE (TDZ) operation	
While remaining in normal operating mode, the user can add and remove Temporary Day Zones and enable/disable day zone operation.	
The panel must initially be disarmed. P64E 2E must be on to enable the use of Temporary Day Zones. See page 20 for more information on Temporary Day Zones.	Press P + E To enter TDZ Selection Mode. then press [Zone No.] + E To select one or more zone to be Temporary Day Zones. then press E To save changes and exit TDZ Selection Mode. Press 0 + E To enable/disable TDZ operation. Temporary Day Zone mode enabled is indicated by the Home icon flashing.

PROGRAMMING

Use one of these Quick Start programming summaries for fast setup of your control panel with typical Local, Audible Monitored or Central Station Monitored options.

QUICK START 1 - LOCAL SYSTEM, SIMPLY PROGRAM A USER CODE

STEP	KEYSTROKES (LCD KP)	DESCRIPTION	COMMENT
1	P 1 2 3 E	Enters User Program Mode.	Program light will turn on. (Default User Code is 123).
2	P 2 0 1 E	Selects the option for User Code 1.	The existing code will be displayed.
3	____ E	Enter your new PIN code followed by E.	User codes can be 3 to 6 digits in length (must not start with zero)
4	____ E	Enter your new PIN code again.	The new code will be displayed.
5	P E	To exit program mode.	Program light will turn off.

QUICK START 2 - AUDIBLE MONITORING

STEP	KEYSTROKES (LCD KP)	DESCRIPTION	COMMENT
1	P 1 2 3 E	Enters User Program Mode.	Program light will turn on. (Default User Code is 123).
2	P 0 0 0 0 0 E	Enters Installer Program Mode.	Program light will flash. (Default Installer Code is 000000).
3	P 2 0 1 E	Selects the option for User Code 1.	The existing code will be displayed.
4	____ E	Enter your new PIN code followed by E.	User codes can be 3 to 6 digits in length (must not start with zero)
5	____ E	Enter your new PIN code again.	The new code will be displayed.
6	P 8 6 E 4 E*	Turns on option P86E 4E	Enables Audible Monitoring.
7	P 7 0 E	Selects the option for Telephone No 1.	
8	_____ E	Enter the phone number followed by E.	30 digits maximum.
9	P E	To exit program mode.	Program light will turn off.

* Note that P86E 4E affects various other options when it is enabled. See notes on page 44.

QUICK START 3 - CENTRAL STATION MONITORING

STEP	KEYSTROKES (LCD KP)	DESCRIPTION	COMMENT
1	P 1 2 3 E	Enters User Program Mode.	Program light will turn on. (Default User Code is 123).
2	P 0 0 0 0 0 E	Enters Installer Program Mode.	Program light will flash. (Default Installer Code is 000000).
3	P 2 0 1 E	Selects the option for User Code 1.	The existing code will be displayed.
4	____ E	Enter your new PIN code followed by E.	Keypad codes can be 3 to 6 digits in length.
5	____ E	Enter your new PIN code again.	The new code will be displayed.
6	P 8 6 E 2 E	Turns on option P86E 2E	Enables Contact ID format.
7	P 7 0 E	Selects the option for Telephone No 1.	
8	_____ E	Enter the telephone number followed by E	30 digits maximum.
8	P 7 2 E	Selects the option for Account No 1.	
10	____ E	Enter the Account number followed by E	4 digits maximum. The account number is supplied by your central monitoring station.
11	P E	To exit program mode.	Program light will turn off.

SPECIAL FUNCTIONS IN PROGRAM MODE

SPECIAL FUNCTION	PROGRAM MODE	KEYPRESS
SEND DIALLER TEST REPORT Send a Dialler Test Report to the telephone number programmed at P70E.	USER	P 6666666 E (<i>eight 6's</i>)
SIREN TEST Turn the Siren, Reset and Strobe Outputs On. Pressing P E will stop the Siren Test (and also exits Program Mode).	USER or INSTALLER	P 7777777 E (<i>eight 7's</i>)
PANEL RESET This function resets the microprocessor. The effect is the same as powering down and powering up again. INSTALLER'S TIP: Use P8888888E prior to powering down for a short time. This will save the current Time Before Next Test Call and the Real Time Clock into permanent memory. On power up these times will be restored.	USER or INSTALLER	P 8888888 E (<i>eight 8's</i>)
DISPLAY SOFTWARE VERSION This function displays the panel software version when in program mode. Displayed in decimal format by the zone LEDs. Example, version V6.1 is displayed by flashing 6 followed by 1.	USER or INSTALLER	P 9999999 E (<i>eight 9's</i>)

FACTORY DEFAULTS

Master Code: 123
Installer Code: 000000



INSTALLER PROGRAM MODE

Installer Program Mode allows access to ALL program options.

NOTE1. When in Installer Program Mode the panel will answer all incoming telephone calls. This allows NessComms to connect via dial-up.

NessComms Direct Connect via the serial port also requires the panel to be in Installer Program Mode.

NOTE2. The panel will remain in Installer Program Mode until P + E is entered by keypad.

INSTALLER'S POWER TIP

All inputs are disabled while the panel is in Installer Program Mode. This handy feature allows you to work on the system without triggering 24 hour zones such as tamper inputs.

USER PROGRAM MODE

User Program Mode allows the owner to program:

- All User Codes
- Entry Exit Times
- Follow Me Telephone number
- Real Time Clock settings

Note: The panel will automatically drop out of User Program Mode to Operating Mode if no keypad buttons are pressed for 4 minutes.

HOW TO ENTER PROGRAM MODE

METHOD 1. FIRST TIME PROGRAMMING – FROM POWER UP

1. Power-up with the PROG/TAMP link OFF.
Replace the PROG/TAMP link (or Box Tamper lead) after programming. The link must be on in normal operating mode.

METHOD 2. USING THE KEYPAD TO ENTER PROGRAM MODE

The panel must be Disarmed.

1. Press (P) [MASTER CODE] (E) The keypad will respond with 3 beeps. This is User Program Mode (PROGRAM light is ON).
2. Press (P) [INSTALLER CODE] (E) The keypad will respond with 3 beeps. This is Installer Program Mode (PROGRAM light is FLASHING).

HOW TO EXIT PROGRAM MODE

1. Press (P) then (E)
Exits directly to Operating Mode (PROGRAM light is OFF).

PROGRAM LEVELS FLOW CHART

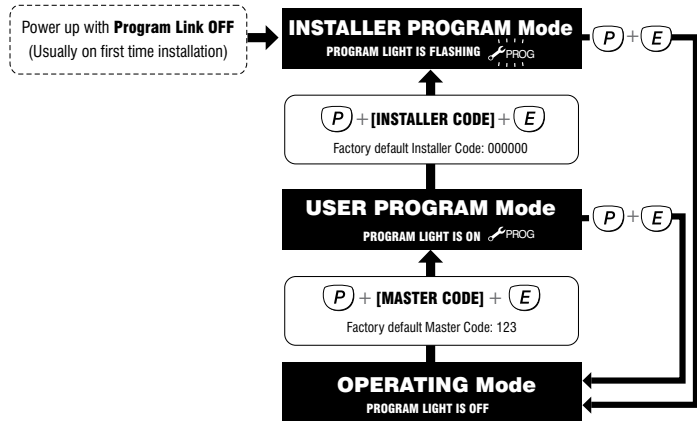

HOW TO PROGRAM A PANEL USING NESS PD

The Ness PD Portable Download tool copies and loads data from panel to panel using the READER header on D8x & D16x panels. Requires D8x/D16x version 7.4 or later.

From Panel to PD

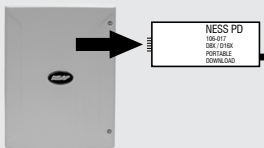

1. The panel should be in **Installation Program Mode**.
2. Connect the NessPD to the READER header on the panel.
3. Remove the PROTECT link on the NessPD.
4. Press P+E to **exit Installation Program Mode**. At this stage, all panel programming options will be automatically copied to the NessPD. The green LED on the NessPD will turn on for 2sec to indicate the data has been saved.
5. Replace the PROTECT link on the NessPD to write-protect the saved data.

From PD to Panel

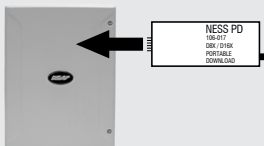

6. The panel should be in **Normal Operating Mode** (or powered off).
7. Connect the NessPD to the READER header on the panel.
8. Use the keypad to **enter Installation Program Mode** (or power up the panel with box tamper unsealed). At this stage, all panel programming options will be automatically copied from the NessPD to the panel. The green LED on the NessPD will turn on for 2sec to indicate the data has been copied.
9. Exit **Installation Program Mode**.

Notes:

1. A NessPD can store defaults for both a D8x and a D16x at the same time. NessPD auto-recognises the panel type and will not copy D8x options into a D16x (or vice versa). Repeat steps 1 to 5 to copy data from both panels.
2. The READER header is normally used for access control. Your 106-012 Weigand Interface, if installed, can be temporarily disconnected while using NessPD.
3. The PROTECT link prevents the NessPD from being overwritten.
4. If The GREEN indicator does not come on, then the NessPD is not connected to the panel. If it comes on briefly then the NessPD is Protected or has no data for that panel model or the data is not compatible (the program option list is different).
5. If the PROTECT link is not installed, any further programming changes made to the panel will be copied to the NessPD.

PROGRAMMING

P101E – P116E

P201E – P256E

PROGRAM MODE LEVEL

User, Installer, Remote by PC (except radio keys and access cards).

FACTORY DEFAULT

User Code 1: 123

All other codes: [blank]

NOTES

1. To clear all codes (except the Installer Code), enter P98E in Installer Program mode. This also defaults user code 1 to 123. See Page 53.

2. Open/Close reports are identified by user number when the control panel is base station monitored.

RELATED OPTIONS

Installer Code. See Page 13, How To Enter Program Mode.

Page 53, Programming The Installer Code.

Installer Code default: 000000

RELATED OPTIONS

Programming Radio Codes, page 74

IMPORTANT NOTES

i A User Code can be a Keypad Code, Radio Code or Reader Code, but only one type at any one time.

i By factory default all user codes are Keypad Codes.

i Any user codes not assigned to be Radio Codes or Reader Codes remain as Keypad Codes.

i When a user code is selected as a Radio Code or Reader Code, its Keypad Code (if any) is automatically deleted. The same applies to Radio Codes and Reader Codes - their codes are auto deleted when the code is changed to any other type.

i User Code 1 is the Master Code and is always a keypad code and cannot be programmed to be a Radio Code or Reader Code.

i User Codes must not start with zero. eg, 01234 is not allowed.

RADIO PROGRAMMING SEE PAGES 72, 73.

USER CODES

D8x and D16x version 5 and later have 56 User Codes which are used to operate the panel by a variety of methods.

Each User Code can be assigned to either a KEYPAD CODE or a RADIO KEY or an ACCESS CARD.

KEYPAD (PIN) CODES

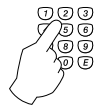

Up to 56 Keypad Codes can be used at up to 3 wired keypads for controlling all panel functions including Arming/Disarming, Home Mode, Panic, memory recall and much more.

- Keypad Codes can be 3 to 6 digits in length and can be individually programmed and deleted.

- Keypad Codes can optionally be programmed to be "Arm Only" codes.
- User Code 1 is also the Master Code which is used to enter Client Program mode.
- All 56 User Codes are Keypad Codes by default. User Codes can be programmed to be Radio Codes or Access Cards as required.
- **USER CODES MUST NOT START WITH ZERO (0). The panel will allow codes with leading zeros but the code will NOT operate the panel.**
- All codes must be unique to each other. Codes are rejected if already used. Some codes that are similar to existing codes may also be rejected.

PROGRAMMING KEYPAD CODES

Press P [Any user option number from 201 to 256] E (The existing code is displayed one digit at a time).

Press [NEW CODE] E [NEW CODE AGAIN] E (The new code is displayed).

Example: To program the Master Code to be 1234.

Press P201E 1234E (1 beep) 1234E (3 beeps)

i When replacing a Keypad Code, the old code does not need to be deleted first. The new code will overwrite the old code.

DELETING KEYPAD CODES

To delete a User Code without programming a new code, press the MEMORY key in place of the code.

Example: To delete User Code 2, press P202E MEMORY E

i A keypad code only needs to be deleted if you're not replacing it with a new code.

ARM ONLY CODES

'Arm Only' is an extra option for user codes. See next page for further information.

User Codes 2–56 can optionally be programmed as Arm Only Codes, which can Arm but cannot Disarm the panel. (Used for cleaners, temporary staff, etc).

Example: To program User Code 2 to be 1234 and an Arm Only code.

Press P202E EXCLUDE E 3E EXCLUDE E 1234E 1234E

(EXCLUDE E enters Extra Options mode, 3E enables the Arm Only option, then EXCLUDE E toggles back to normal user code program mode.)

When the code is viewed in program mode, the ARMED icon is briefly displayed before the digits of the code.

To disable the Arm Only feature for a keypad code, simply enter the option for that code, press EXCLUDE E to view Extra Options then press 3 E without re-entering a new code. This retains the existing code and toggles off the Arm Only feature.

i The Arm Only feature also applies to Radio Keys and Access Cards.

i Arm Only codes can also arm the panel directly from Home Mode. (Normally, user codes can arm the panel only if it is fully disarmed).

i Arm Only codes can also arm Home Mode as normal.

i Radio Keys programmed as an Arm Only can toggle the armed/disarmed state of the panel using the OFF button on the radio key.

**USER CODE
OPTIONS TABLE**

LCD KEYPAD EXCLUDE+E toggles Extra Options mode.
NAVIGATOR KEYPAD Press Extra Code Options.
(Installer Program mode only)

USER CODE	OPTION NO.	KEYPAD PIN	1E AREA 1 CODE	2E AREA 2 CODE	3E ARM ONLY	4E "CODE ONLY" ARM (REX CODE)	5E RADIO CODE	6E Reader Code 1	7E Reader Code 2	8E Reader Code 3	9E Au- toTime Code
1 (Master)	P201E	123	ON	ON							
2	P202E		ON								
3	P203E		ON								
4	P204E		ON								
5	P205E		ON								
6	P206E		ON								
7	P207E		ON								
8	P208E		ON								
9	P209E		ON								
10	P210E		ON								
11	P211E		ON								
12	P212E		ON								
13	P213E		ON								
14	P214E		ON								
15	P215E		ON								
16	P216E		ON								
17	P217E		ON								
18	P218E		ON								
19	P219E		ON								
20	P220E		ON								
21	P221E		ON								
22	P222E		ON								
23	P223E		ON								
24	P224E		ON								
25	P225E		ON								
26	P226E		ON								
27	P227E		ON								
28	P228E		ON								
29	P229E		ON								
30	P230E		ON								
31	P231E		ON								
32	P232E		ON								
33	P233E		ON								
34	P234E		ON								
35	P235E		ON								
36	P236E		ON								
37	P237E		ON								
38	P238E		ON								
39	P239E		ON								
40	P240E		ON								
41	P241E		ON								
42	P242E		ON								
43	P243E		ON								
44	P244E		ON								
45	P245E		ON								
46	P246E		ON								
47	P247E		ON								
48	P248E		ON								
49	P249E		ON								
50	P250E		ON								
51	P251E		ON								
52	P252E		ON								
53	P253E		ON								
54	P254E		ON								
55	P255E		ON								
56	P256E		ON								

USER CODES

ASSIGNING EXTRA OPTIONS

Each user code has several "extra options" which can be assigned when programming the code or at any time later.

In **NORMAL USER CODE PROGRAMMING mode** you can do the following:

- Program Keypad Codes (see page 14).
- Program Radio Codes (see page 74).
- Program Access cards (see page 76).
- View radio signal strength (see page 72).

In **EXTRA OPTIONS mode** you can assign several powerful functions to each user code. See below.

To view and program the Extra Options:

- LCD KEYPAD** 1. Select a User Code (P201–P256E)
- 2. Press EXCLUDE E. *The Exclude light turns ON.*
- NAVIGATOR KEYPAD** Press Extra Code Options.

The following Extra Options can now be changed:

- 1E AREA 1 CODES.** Assign/remove user codes to Area 1. (By default all user codes are assigned to Area 1.)
 - 2E AREA 2 CODES.** Assign/remove user codes to Area 2.
 - i** User codes can be assigned to Area 1, Area 2, both areas or no areas.
 - i** An Area will not arm unless it has one or more zones assigned to it (P45E, P46E).
 - i** If a code is not assigned to any Area/s, the code can be used for special functions such as to trigger outputs.
 - 3E ARM ONLY.** User Codes 2–56 can be programmed to Arm but not Disarm the panel. (See page 14).
 - 4E "CODE ONLY" ARMING.** Enables selected user codes to allow "code only arming". Arming can then be done with or without the use of the arm key on the keypad.
 - i** In the case of radio codes the radio key OFF button will toggle the armed state of the area assigned to the radio key.
 - i** If the User code is assigned to both AREA 1 and AREA 2. If AREA 1 is already armed, then entering the code will disarm AREA 1 - but arm AREA 2.

If the intention is to either ARM or DISARM both areas using this code then ARM + [code] must be used first to arm both areas. Once both are armed they can be disarmed.

 - i** If in Home mode, the action is to exit Home mode.
 - i** Codes selected for Code Only Arming and not assigned to any areas are automatically REX codes. See page 82.
- 5E RADIO CODE.** Enables selected user codes as Radio Codes for operation by Ness Radio Key or Radio Keypad. (Page 74 - how to program Radio Codes).
- 6E READER CODE 1.** Enables user codes as Access Control codes assigned to Reader 1. (Page 76 - Access Cards).
- 7E READER CODE 2.** Enables user codes as Access Control codes assigned to Reader 2. (Page 76 - Access Cards).
- 8E READER CODE 3.** Enables user codes as Access Control codes assigned to Reader 3. (Page 76 - Access Cards).
 - i** A user code can be assigned to any one, two or all three access control readers.
- 9E ENABLE FOR AUTOTIME.** Enables user codes for use by AutoTime. (See page 71, Enable/Disable User Codes Via AutoTimer).

PROGRAMMING

Option No.	Description	Default	Note
P26E	ENTRY DELAY TIME 1	20	seconds
P27E	ENTRY DELAY TIME 2	6	x10 = 60seconds
P28E	EXIT DELAY TIME	60	seconds
P29E	SIREN RESET TIME	5	minutes

P26E

PROGRAM MODE LEVEL

User, Installer mode or NessComms.

FACTORY DEFAULT

20 (seconds)

NOTES

- Programmable from 1 – 99 seconds.
- The Entry Delay Time also sets the delay before Auto Re-Arming. See P68E 2E page 34.

RELATED OPTIONS

P120E 7E Entry Delay Extender

ENTRY DELAY TIME1

The Entry Delay Time 1 is the time given to disarm the panel after a Entry Delay 1 zone is unsecured.

The Entry Delay Time1 setting is from 1 to 99 seconds in 1 second increments. Entry Delay Time1 can be up to a maximum of 990 seconds by enabling option P120E 7E.

TO PROGRAM

- Press P26E (The existing time will be displayed).
- Press [NEW TIME] E (The new time will be displayed).

P27E

PROGRAM MODE LEVEL

User, Installer mode or NessComms.

FACTORY DEFAULT

6 (= 60 seconds)

NOTES

Programmable from 10 – 990 seconds.

ENTRY DELAY TIME2

The Entry Delay Time2 is the time given to disarm the panel after an Entry Delay2 zone is unsecured.

The Entry Delay Time2 setting is from 10 to 990 seconds (1 – 99).

Note: The Entry Delay Time2 is set in 10 second increments so that a value setting of 6 means a 60 seconds delay.

PROGRAMMING SEQUENCE:

- P27E existing time is displayed one digit at a time*
- [ENTER NEW TIME] E *new time is displayed one digit at a time*
- EXAMPLE: To program Entry Delay Time2 to be 600 seconds:**
- P27E 60E**

P28E

PROGRAM MODE LEVEL

User, Installer mode or NessComms.

FACTORY DEFAULT

60 (seconds)

NOTES

Programmable from 1 – 99 seconds

RELATED OPTIONS

P62E 8E Exit Time x10

EXIT DELAY TIME

The Exit Delay Time is the time given to secure and depart the premises after the panel is armed. All zones (except 24hr zones) are inactive during the Exit Delay time.

The Exit Delay Time setting is from 1 to 99 seconds in 1 second increments.

PROGRAMMING SEQUENCE:

- P28E existing time is displayed one digit at a time*
- [ENTER NEW TIME] E *new time is displayed one digit at a time*
- EXAMPLE: To program Exit Delay to be 85 seconds:**
- P28E 85E**

P29E

PROGRAM MODE LEVEL

Installer mode or NessComms.

FACTORY DEFAULT

5 (minutes)

NOTES

- Programmable from 1 – 99 minutes.
- Siren times of longer than 5 minutes are contrary to noise pollution regulations in most areas.

SIREN RESET TIME

The Siren Reset Time sets the duration of the Siren and Reset outputs.

The Siren Reset Time setting is from 1 to 99 minutes in 1 minute increments.

PROGRAMMING SEQUENCE:

- P29E existing time is displayed one digit at a time*
- [ENTER NEW TIME] E *new time is displayed one digit at a time*
- EXAMPLE: To program Siren Time to be 4 minutes:**
- P29E 4E**

P30E – P36E

PROGRAM MODE LEVEL

Installer mode or NessComms.

FACTORY DEFAULT

Normal sensitivity.

P30E, all zones = ON.

NOTES

- Sensitivity can be individually programmed for each zone.
- Zones are allocated to one sensitivity level at any one time. Turning a zone ON in a sensitivity level, turns the zone OFF in any other sensitivity level.
- To revert zone sensitivity back to Normal, turn on the required zone/s at P30E.

i Sensitivity Level "Extreme" (P31E) is provided as a guide to the upper limit and should **NOT BE USED**.

i For compatibility with existing installations, the sensitivity levels P31E to P36E are identical to previous versions of D8/D16.

VIBRATION SENSITIVITY

Each zone has individually adjustable sensitivity for connection of Nessensor Vibration Sensors. Zone sensitivity is adjusted by toggling zones ON in options P30E to P36E.

P30E is Normal Sensitivity, vibration analyser disabled. This is used for normal alarm devices. Zone response time, 200ms.

P31–36E are the options for the 6 levels of vibration sensitivities. P31E is the most sensitive setting.

PROGRAMMING SEQUENCE:

P [30–38] E zones are displayed [Zone No] E

EXAMPLE: To program zones 2 and 3 to be Medium sensitivity:

P34E 2E 3E the keypad display will show zone lights 2 & 3 on.

Option No.	Description	ZONES 1–8 (D8 & D16)								ZONES 9–16 (D16)							
		1	2	3	4	5	6	7	8	9	10	11	12	13	14	15	16
P30E	NORMAL	ON	ON	ON	ON	ON	ON	ON	ON	ON	ON	ON	ON	ON	ON	ON	ON
VIBRATION OPTIONS	P31E	Vibration EXTREME*															
	P32E	Vibration HIGHEST															
	P33E	Vibration HIGH															
	P34E	Vibration MEDIUM															
	P35E	Vibration LOWER															
	P36E	Vibration LOWEST															
P37E	1 second ZONES																
P38E	3 second ZONES																

* Extreme sensitivity (P31E) should not be used. It is provided as a guide only



ADJUSTING NESSENSORS

Nessensors are sensitive to high frequencies and insensitive to low frequencies. Therefore it is not necessary to apply much force to the protected structure, rather a very rapid succession of blows.

The sensitivity has been correctly adjusted when a single blow applied with a soft object (e.g. by hand) does not cause an alarm whereas a rapid series of blows (using a metal object such as a screwdriver blade) will cause an alarm.

NESSENSOR™ Vibration Sensor
Part No. VIB500

In addition to zone sensitivity adjustment, the overall sensitivity of the Nessensor can be adjusted by rotating the body of the Nessensor within its bracket.

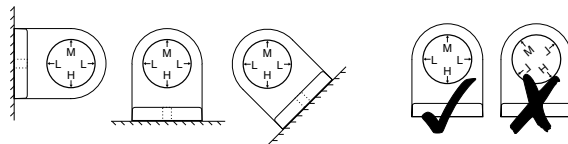

The Nessensor bracket must always be mounted horizontally and the arrow must point up for any required setting.

P37E – P38E

PROGRAM MODE LEVEL

Installer mode or NessComms.

FACTORY DEFAULT

all off

NOTES

- A Long Response Zone cannot be a Normal Zone or Vibration zone at the same time.
- To convert zone/s back to a Normal Zone, turn on the required zone/s at P30E.

RELATED OPTIONS

P301E 5E-7E Request To Exit (REX)

LONG RESPONSE ZONES

Long Response Zones are normal alarm zones with a long reaction time. Individual zones can be programmed to have either a 1 second response (P37E) or 3 second response (P38E).

This is useful where zones 5, 6 or 7 have been programmed as REX inputs for access control purposes, (P301E 5E-7E). To prevent accidental door opening, the REX button then must be pressed and held for 1sec or 3sec, as programmed.

PROGRAMMING SEQUENCE:

P37E or P38E [Zone No]E toggles zones ON and OFF

PROGRAMMING

Option No.	Description	ZONES 1-8 (D8 & D16)								ZONES 9-16 (D16)							
		1	2	3	4	5	6	7	8	9	10	11	12	13	14	15	16
P39E	DOUBLE TRIGGER zones																
P40E	INSTANT zones			ON	ON	ON	ON	ON	ON	ON	ON	ON	ON	ON	ON	ON	ON
P41E	ENTRY DELAY 1 zones	ON															
P42E	HANDOVER zones		ON														
P43E	ENTRY DELAY 2 zones																
P44E	LOCKOUT zones (Reset O/P)	ON	ON	ON	ON	ON	ON	ON	ON	ON	ON	ON	ON	ON	ON	ON	ON
P45E	AREA 1 zones	ON	ON	ON	ON	ON	ON	ON	ON	ON	ON	ON	ON	ON	ON	ON	ON
P46E	AREA 2 zones																
P51E	HOME zones																
P52E	24HR zones																
P53E	DAY zones																

ZONE DELAY TYPES
 Only one option per zone can be selected. For example; a zone cannot be instant and delayed at the same.

P39E

PROGRAM MODE LEVEL

Installer mode or NessComms.

FACTORY DEFAULT

All OFF: No Double Trigger zones.

NOTES

- Double Trigger is useful for preventing unwanted alarms from zones in harsh environments such as sheds and garages.

• **0E** will turn all selections OFF.

MEMORY E will turn all selections ON.

DOUBLE TRIGGER ZONES

Zones programmed to Double Trigger will recognise an alarm condition if:

- The zone has been triggered twice within a 4 minute period.
- If any 2 zones (both programmed for double trigger), each trigger once.
- The zone is left unsealed for longer than 15 seconds.

PROGRAMMING SEQUENCE:

P39E [Zone No]E toggles the options ON and OFF

[Zone No] OFF: The zone is not a Double Trigger zone

[Zone No] ON: The zone is a Double Trigger zone

P40E

PROGRAM MODE LEVEL

Installer mode or NessComms.

FACTORY DEFAULT

D8, 3E-8E ON: Zones 3-8 are Instant.

D16, 3E-16E ON: Zones 3-16 are Instant.

NOTES

- When a zone is selected for this type, it is automatically deselected from any other zone type in the DELAY GROUP.

INSTANT ZONES

Instant Zones operate only in the Armed state. When Armed at the expiry of exit time, Instant Zones will activate assigned outputs immediately when triggered.

PROGRAMMING SEQUENCE:

P40E [Zone No]E turns the options ON

[Zone No] ON: The zone is an Instant Zone

To deselect the option, select a different zone type in the DELAY GROUP.

P41E

PROGRAM MODE LEVEL

Installer mode or NessComms.

FACTORY DEFAULT

1E ON: Zone 1 has Entry Delay1.

NOTES

- The keypad sonalert will beep during Entry Delay as a reminder to disarm the panel. Entry beeps can be disabled by program option P60E 1E.

• When a zone is selected for this type, it is automatically deselected from any other zone type in the DELAY GROUP.

ENTRY DELAY1 ZONES

Entry Delay1 zones operate only in the Armed state. When Armed, at the expiry of exit time these zones will activate the Entry Delay Timer1 (P26E) when they are triggered. If the panel is not disarmed before the expiry of the Entry Delay Timer1, the alarm outputs will be activated.

PROGRAMMING SEQUENCE:

P41E [Zone No]E turns the options ON

[Zone No] ON: The zone is an Entry Delay1 zone

To deselect the option, select a different zone type in the DELAY GROUP.

P42E

PROGRAM MODE LEVEL

Installer mode or NessComms.

FACTORY DEFAULT

2E ON: Zone 2 is a Handover zone.

NOTES

- When a zone is selected for this type, it is automatically deselected from any other zone type in the DELAY GROUP.

P43E

PROGRAM MODE LEVEL

Installer mode or NessComms.

FACTORY DEFAULT

All OFF: No zones have Entry Delay2.

NOTES

P44E

PROGRAM MODE LEVEL

Installer mode or NessComms.

FACTORY DEFAULT

All ON: All zones are Lockout zones.

NOTES

- The SIREN output always locks out.
- 0E will turn all selections OFF.
- MEMORY E will turn all selections ON.

RELATED OPTIONS

P60E 4E Tamper Reset Lockout.

P78E Multiple alarm reports.

HANDOVER ZONES

Handover zones are delayed only if entry is made through an Entry Delay zone first. If a Handover zone is triggered first, the zone behaves as an instant zone. Normally, the “point of entry” zone should be Delay zone, with any other zones in the entry path programmed as Handover zones.

PROGRAMMING SEQUENCE:

P42E [Zone No]E turns the options ON

P42E [Zone No]E ON: The zone is a Handover zone

To deselect the option, select a different zone type in the DELAY GROUP.

ENTRY DELAY2 ZONES

When an Entry Delay2 zone is triggered, it has entry delay as set by the Entry Delay Time2 (P27E).

PROGRAMMING SEQUENCE:

P43E [Zone No]E turns the options ON

P43E [Zone No]E ON: The zone is an Entry Delay2 zone

To deselect the option, select a different zone type in the DELAY GROUP.

RESET LOCKOUT ZONES

All zones and tamper input can be programmed to Lockout, i.e. cause the RESET OUTPUT to sound only once while the panel is armed.

The RESET OUTPUT is then locked out for that alarmed zone until entering a valid code has reset the panel. If using area partitioning, disarming either partition resets the zone lockout for both partitions.

PROGRAMMING SEQUENCE:

P44E [Zone No]E toggles the options ON and OFF

P44E [Zone No]E OFF: The zone is not a Lockout zone

P44E [Zone No]E ON: The zone is a Lockout zone

AREA PARTITIONING

ASSIGNING ZONES TO AREAS

Option No.	Description	ZONES 1-8 (D8 & D16)								ZONES 9-16 (D16)							
		1	2	3	4	5	6	7	8	9	10	11	12	13	14	15	16
P45E	AREA 1 ZONES	ON	ON	ON	ON	ON	ON	ON	ON								
P46E	AREA 2 ZONES																

P45E, P46E

PROGRAM MODE LEVEL

Installer mode or NessComms.

FACTORY DEFAULT

No zones assigned to Area 2.

NOTES

- For options P45E and P46E, [Zone No] E toggles the selection ON and OFF.
- Zones assigned to BOTH areas become Common zones.
- If no Area operation is required, assign all zones to Area 1. (This is also the factory default).

ASSIGNING ZONES TO AREAS

Assign (or remove) zones that will operate in Area 1 and/or Area 2.

PROGRAMMING SEQUENCE:

P45E [Zone No]E toggles the options ON and OFF for Area 1

[Zone No] OFF: The zone is not in Area 1

[Zone No] ON: The zone is in Area 1

P46E [Zone No]E toggles the options ON and OFF for Area 2

[Zone No] OFF: The zone is not in Area 2

[Zone No] ON: The zone is in Area 2

EXAMPLE:

To program zones 1-4 for Area 1 and zones 1, 5-8 for Area 2.

In this example, we have assigned zone 1 to both areas, so it becomes a Common Zone.

P45E use the [Zone No] E sequence to turn ON only zones 1-4.

P46E use the [Zone No] E sequence to turn ON zone 1 and zones 5-8.

PROGRAMMING

AREA PARTITIONING

DEFINITION

Area Partitioning allows the control panel zones to be split into two partitions; Area1 and Area2. The panel then effectively operates as two separate systems sharing only the siren outputs and dialler.

COMMON AREA ZONES

Zones assigned to both Areas are armed only when Area1 and Area2 are both armed. This allows the Common Area zone/s to be shared by both Areas.

For example, Office A and Office B operate as separate areas but the entrance foyer used by both offices is assigned to both areas meaning it will automatically arm when both Areas have armed. The Common Area then automatically disarms when either Area1 or Area2 disarms.

USER CODE ASSIGNMENT

A User Code assigned to an Area can arm and disarm only that Area. User Codes assigned to both Areas will operate both Areas simultaneously.

OPERATION

Arming and disarming is carried out as normal from a single keypad or separate keypads installed in both areas or by Radio Key.

Area operation only applies to zones when they are in the armed state. This means that Day zones and 24hr zones are independent of area operations.

AREA PARTITIONING & HOME MODE

The panel can be armed in Home mode if Area2 is already armed on these conditions:

1. Area 1 must be OFF.
2. Area 2 must be armed first, and then Home armed – not the reverse.
3. Zones assigned to both Home mode (P51E) and to Area 2 (P46E) will act as Home zones when both Area 2 and Home are armed.
4. Zones must be assigned to P51E to allow Home arm.
5. User codes assigned only to Area2 can arm but **will not disarm Home Mode**.

Note: Home arming when AREA 2 is armed cannot be done by Radio Key (double OFF button) or by keyswitch.

Note: Home Mode is not available when Area 1 is armed.

HOME MODE

Home Mode allows selected zones to be armed while the system is disarmed. For example, this is often used to arm door and windows sensors overnight, while allowing free movement within the premises.

1. Home Mode will not arm if Area 1 is armed.
2. Home Mode will not arm if there are no Home zones programmed, (P51E).
3. User codes assigned only to Area2 can arm but will not disarm Home Mode.
4. Zones which are to be armed in Home Mode are selected using option P51E.
5. Home Mode can be armed by Keypad, Radio Key or Access Card.
6. Audible outputs in Home Mode (set by options P63E 1E-4E) are independent of audible outputs in fully armed mode.
7. If dialler reporting is enabled, Home Mode alarms will be reported as normal providing that:
 - a/ The zone/s are selected to report alarms by option P74E.
 - b/ Options P64E 1E & 3E are off. (Brief Home Alarm, Home Entry Delay2).
8. Zones selected to be Entry Delay1 zones also have entry delay in Home Mode.
9. If Home Zones Entry Delay2 (P64E 3E) is enabled, then *all* Home zones will have entry delay as set by P27E.

TEMPORARY DAY ZONES

The Temporary Day Zone feature allows easy and flexible Day Zone selection and operation.

While remaining in normal operating mode, the user can add and remove Temporary Day Zones and enable/disable day zone operation using simple key strokes.

TO ENABLE TEMPORARY DAY ZONES

To enable Temporary Day Zone selection and operation, the Brief Day Alarm feature (installer option P64E 2E) must be ON. If P64E 2E is OFF, the Temporary Day Zone feature will be unavailable but Permanent Day Zones will still operate and will sound the programmed output while the zone is unsealed.

P64E 2E is OFF by default.

USER COMMANDS (In normal Operating Mode).

(P) + (E) Selection Mode. Enter **P** followed by **E** when in operating mode to enter Temporary Day Zone selection mode.

[Zone No.] + (E) Zone Selection. To select or deselect zones to be Temporary Day Zones. The selected zones are indicated by the corresponding zone number.

Permanent Day Zones, (set by installer option P53E), are not displayed in selection mode. Permanent Day Zones can be selected as Temporary Day Zones but this has no effect as those zones are already day zones.

(E) Saves changes and returns to normal operating mode.

(O) + (E) Enables and Disables Day Mode. This enables/disables both Temporary and Permanent Day Zones.

INDICATION

The Home icon flashes continuously when Temporary Day Mode is enabled.

OPERATION

When Day Mode is enabled, any unsealed day zone will sound the programmed output for 2 seconds. When Day Mode is disabled, an unsealed day zone will simply be indicated on the keypad as an unsealed zone.

KPX CHIME

The KPX keypad has a special two tone chime which can be enabled in place of the default beep warning tone. See P126E 4E.

AUX 2 OPTION

When the Temporary Day Zone feature is enabled, the installer option P63E 6E selects Aux 2 output instead of the strobe output. This allows a remote warning device such as a buzzer to be connected for day zone warning. This may be needed if an additional audible day zone warning is needed, although the keypad sonalert, (P63E 7E), is more than adequate in most cases.

RELATED OPTIONS

P64E 2E, Brief Day Alarm. Turn this option on to enable Temporary Day Zones. Factory default = OFF.

P63E 5E, Day Mode to Reset output.

P63E 6E, Day Mode to Strobe output.

If P64E 2E is ON, then this option sends day alarms to the AUX 2 output.

P63E 7E, Day Mode to Sonalert.

P63E 8E, Day Mode to Siren output.

P53E, Permanent Day Zone selection.

P126E 4E, Enable KPX Chime in Day Mode

(I) Temporary Day Zone selections will be lost if the panel is powered down or reset, but are not affected by arming/disarming or entering program mode.

P47E, P48E, P49E, P50E

See page 14, 15 programming User Codes.

P51E

PROGRAM MODE LEVEL

Installer mode or NessComms.

FACTORY DEFAULT

all OFF: No Home zones.

NOTES

By default, all Home zones have Entry Delay2, see P64E 3E. If this option is off Home zones have normal entry delay attributes set by options P40E–P42E.

RELATED OPTIONS

P63E Home Mode output mapping.

P64E 1E Brief Home alarm.

P64E 3E Home zones have Entry Delay2.

P69E 3E Quiet Home siren.

P69E 5E Radio Key ON or OFF button arms Home Mode.

P120E 2E Home arm chirps by radio key.

P120E 3E Radio Key AUX button arms Home mode.

P120E 6E Smart Beeps for Home and Day zones.

P52E

PROGRAM MODE LEVEL

Installer mode or NessComms.

FACTORY DEFAULT

All OFF: No 24hr zones.

NOTES

- The Tamper input is always a 24hr zone.
- For silent 24hr zones, deselect the zone/s from options P54E-P57E (Reset, Strobe, Sonalert & Siren).
- To change a 24hr zone to any other zone type, the zone must also be re-assigned to an AREA (P45E or P46E).

P53E

PROGRAM MODE LEVEL

Installer, Remote by PC

FACTORY DEFAULT

all OFF: No Day zones

RELATED OPTIONS

P63E 5E-8E Day zone output mapping.

P64E 2E Brief Day Mode alarm.

P120E 6E Smart Beeps for Home and Day zones.

TYPICAL USES FOR DAY ZONES: Instant alert when a delivery door is opened, doorway alert for a shop.

ASSIGNING USER CODES TO AREAS

Options P201E–P256E are now used for assigning user codes to areas.

(Experienced users can still use options P47E–P50E for this function, but only up to user code 15).

HOME ZONES

Home zones allow you to Arm selected zones while others are ignored. Typically used for perimeter zones such as windows and doors while you are at home.

For example: upstairs zones are Disarmed while downstairs zones are Armed in Home mode.

PROGRAMMING SEQUENCE:

P51E [Zone No]E toggles the options ON and OFF

P51E [Zone No]E OFF: The zone is not a Home zone

P51E [Zone No]E ON: The zone is a Home zone

NOTE: Zones selected to Report Zone Alarms (P74E) will by default report alarms in Home Mode, (if the dialler is enabled).

The Brief Home Alarm option P64E 1E, when enabled, prevents Home alarms from reporting.

See page 20 for Home operation.

24hr ZONES

24hr Zones operate at all times regardless of the mode of panel operation, i.e. Armed, Disarmed or Home Monitor. When alarmed, these zones will activate assigned outputs immediately. To reset those alarms a valid user code must be entered.

Selecting a zone as 24hr will override any other zone type setting such as Instant, Delayed or Handover. 24hr zones are independent of Area operation. All other zone types must be assigned to at least one Area to become active.

PROGRAMMING SEQUENCE:

P52E [Zone No]E toggles the options ON and OFF

[Zone No] OFF: The zone is not a 24hr zone

[Zone No] ON: The zone is a 24hr zone

DAY ZONES

Day Zones operate when the panel is fully disarmed, i.e. when Area 1, Area 2 and Home are all off. When alarmed, these zones will activate their assigned outputs instantly.

The outputs mapped to the Day Zone will turn on while the zone is unsealed. Turn P64E 2E on, to limit Day Zone alarms to 2 seconds.

The Temporary Day Zones feature allows day mode to be easily enabled/disabled and day zones added/removed by the user from any keypad.

PROGRAMMING SEQUENCE:

P53E [Zone No]E toggles the options ON and OFF

[Zone No] OFF: The zone is not a Day zone

[Zone No] ON: The zone is a Day zone

See page 20 for information on TEMPORARY DAY ZONES.

PROGRAMMING

ZONE TO OUTPUT MAPPING

When a zone alarms, it can turn on any or all of the following 6 outputs: Sonalert, Strobe, Siren, Reset, AUX1, AUX2.

The programming is selected with options P54E – P59E. Simply set the zone number to the output to select it. The zone LED will indicate if the zone is selected.

The Tamper Input and the Keypad Panic can be programmed to turn on the Reset, Strobe, Sonalert and Siren by using option P61E.



Zone To Output Mapping applies to zones when the panel is in the Armed or 24hr state. For Home and DAY mode Output Mapping – see Option P63E 1E–8E, page 28.

MAPPING ZONES TO OUTPUTS		ZONES 1–8 (D8 & D16)								ZONES 9–16 (D16)							
		1	2	3	4	5	6	7	8	9	10	11	12	13	14	15	16
Option No.	Description																
P54E	RESET Zones	ON	ON	ON	ON	ON	ON	ON	ON	ON	ON	ON	ON	ON	ON	ON	ON
P55E	STROBE Zones	ON	ON	ON	ON	ON	ON	ON	ON	ON	ON	ON	ON	ON	ON	ON	ON
P56E	SONALERT Zones	ON	ON	ON	ON	ON	ON	ON	ON	ON	ON	ON	ON	ON	ON	ON	ON
P57E	SIREN Zones	ON	ON	ON	ON	ON	ON	ON	ON	ON	ON	ON	ON	ON	ON	ON	ON
P58E	AUX1,3 Zones																
P59E	AUX2,4 Zones																

P54E

PROGRAM MODE LEVEL

Installer mode or NessComms.

FACTORY DEFAULT

All ON: All zones trigger Reset output.

NOTES

- 0E will turn all selections OFF.
- MEMORY E will turn all selections ON.

RESET OUTPUT ZONES

Selects the zones to trigger the Reset output.

PROGRAMMING SEQUENCE:

P54E [Zone No]E toggles the options ON and OFF

[Zone No] OFF: The zone will not trigger the Reset output

[Zone No] ON: The zone will trigger the Reset output

P55E

PROGRAM MODE LEVEL

Installer mode or NessComms.

FACTORY DEFAULT

all ON: All zones trigger Strobe output.

NOTES

- 0E will turn all selections OFF.
- MEMORY E will turn all selections ON.

STROBE OUTPUT ZONES

Selects the zones to trigger the Strobe output.

PROGRAMMING SEQUENCE:

P55E [Zone No]E toggles the options ON and OFF

[Zone No] OFF: The zone will not trigger the Strobe output

[Zone No] ON: The zone will trigger the Strobe output

P56E

PROGRAM MODE LEVEL

Installer mode or NessComms.

FACTORY DEFAULT

All ON: All zones sound the Keypad Sonalert.

NOTES

- 0E will turn all selections OFF.
- MEMORY E will turn all selections ON.

KEYPAD SONALERT ZONES

Selects the zones which will sound the Keypad Sonalert (beeper).

PROGRAMMING SEQUENCE:

P56E [Zone No]E toggles the options ON and OFF

[Zone No] OFF: The zone will not trigger the Keypad Sonalert

[Zone No] ON: The zone will trigger the Keypad Sonalert

P57E

PROGRAM MODE LEVEL

Installer mode or NessComms.

FACTORY DEFAULT

All ON: All zones trigger Siren output.

NOTES

- 0E will turn all selections OFF
- MEMORY E will turn all selections ON

P58E

PROGRAM MODE LEVEL

Installer mode or NessComms.

FACTORY DEFAULT

All OFF: No zones trigger AUX 1 or 3

NOTES

- 0E will turn all selections OFF.
- MEMORY E will turn all selections ON.

RELATED OPTIONS

P121E 5E-8E Day zone output mapping.

P59E

PROGRAM MODE LEVEL

Installer mode or NessComms.

FACTORY DEFAULT

All OFF: No zones trigger AUX 2 or 4

NOTES

- 0E will turn all selections OFF.
- MEMORY E will turn all selections ON.

SIREN OUTPUT ZONES

Selects the zones to trigger the Siren output.

PROGRAMMING SEQUENCE:

P57E [Zone No]E toggles the options ON and OFF

[Zone No] OFF: The zone will not trigger the Siren output

[Zone No] ON: The zone will trigger the Siren output

AUX1,3 OUTPUT ZONES

Selects the zones to trigger the AUX1 or AUX3 outputs. This option selects *which* zones trigger AUX1 or 3.

Use P121E 1E and/or P123E 1E to enable the output.

Once turned on by a zone alarm, the output will remain on until the panel is reset/disarmed.

PROGRAMMING SEQUENCE:

P58E [Zone No]E toggles the options ON and OFF

[Zone No] OFF: The zone will not trigger AUX1,3 output/s

[Zone No] ON: The zone will trigger the AUX1,3 output/s

AUX2,4 OUTPUT ZONES

Selects the zones to trigger the AUX2 or AUX4 outputs. This option selects *which* zones trigger AUX2 or 4.

Use P122E 1E and/or P124E 1E to enable the output.

Once turned on by a zone alarm, the output will remain on until the panel is reset/disarmed.

PROGRAMMING SEQUENCE:

P59E [Zone No]E toggles the options ON and OFF

[Zone No] OFF: The zone will not trigger the AUX2,4 output/s

[Zone No] ON: The zone will trigger the AUX2,4 output/s

PROGRAMMING

Option No.	Description	Default	
P60E	1E	Entry Beeps	ON
	2E	Keyswitch Home Monitor/Disarm	OFF
	3E	Keyswitch Arm/Disarm	OFF
	4E	Tamper Siren lockout	ON
	5E	Duress to RESET output	OFF
	6E	Auto Exclude zones	ON
	7E	Auto keypad display off	OFF
	8E	Delayed Aux3, Aux4 outputs	OFF

P60E 1E

PROGRAM MODE LEVEL

Installer mode or NessComms.

FACTORY DEFAULT

Entry Beeps ON.

RELATED OPTIONS

P69E 7E Arm Exit Beeps.

P69E 8E Home Exit Beeps.

ENTRY BEEPS

The sonalert will beep during Entry Delay.

PROGRAMMING SEQUENCE:

P60E 1E toggles the option ON and OFF

OFF: Entry Beeps OFF

ON: Entry Beeps ON

P60E 2E, 3E

PROGRAM MODE LEVEL

Installer mode or NessComms.

FACTORY DEFAULT

No keyswitch enabled.

P60E 2E, 3E off.

NOTES

The keyswitch:

a/ Always Arms Area1 only.

b/ Does not arm Area2.

c/ Can disarm Area2 if option P120E 8E is enabled.

• Use a 2K2 resistor on the keyswitch input regardless of the global EOL resistor value set by P129E. Also see P129E, page 68.

RELATED OPTIONS

P120E 1E Latched Keyswitch.

P120E 4E Keyswitch Disarms only.

P120E 5E Keyswitch Arms only.

P120E 8E Keyswitch disarm Area2.

P129E EOL Resistor value

KEYSWITCH OPERATION

An externally fitted, normally open momentary Keyswitch can be used to Arm, Disarm or arm the Home mode.

The keyswitch is wired to zone 8 (zone 8 is then no longer available as a normal alarm input, but is still available for use as a Radio Zone).

PROGRAMMING SEQUENCE:

P60E 2E or 3E toggles the option ON and OFF

2E & 3E OFF: No keyswitch operation. Zone 8 is a normal alarm input.

2E ON: Keyswitch cycles between Home and Disarm.

3E ON: Keyswitch cycles between Arm and Disarm.

2E & 3E ON: Keyswitch cycles between Arm, Home and Disarm.

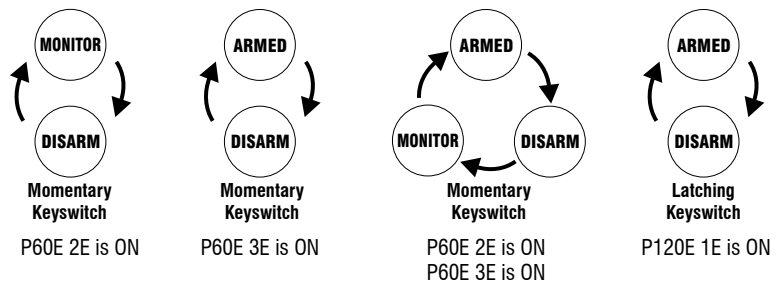

KEYSWITCH WIRING

If P60E 2E or 3E are enabled, use a momentary action keyswitch with normally open contacts. A momentary closed circuit across the resistor will toggle panel arming modes. Open circuit the resistor to trigger Panic if required. (Panic on this input is disabled if P120E 1E is enabled).

If P120E 1E is enabled, use a latching keyswitch. When the resistor is sealed, panel is disarmed. If the resistor is unsealed, (either by open circuit or short circuit), the panel will arm Area1, (Area2 will be ignored).

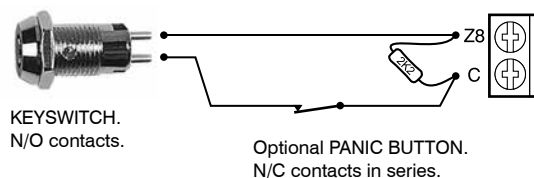

KEYSWITCH WIRING.

A momentary or latching keyswitch can be wired as shown.

Always use a 2K2 resistor regardless of the global EOL resistor value set by P129E)

P60E 4E

PROGRAM MODE LEVEL

Installer mode or NessComms.

FACTORY DEFAULT

ON Tamper Reset Lockout enabled.

RELATED OPTIONS

P44E Lockout zones.

P60E 5E

PROGRAM MODE LEVEL

Installer mode or NessComms.

FACTORY DEFAULT

OFF No Reset output on Duress alarm.

RELATED OPTIONS

P75E 1E Enable reporting of Duress.

P60E 6E

PROGRAM MODE LEVEL

Installer mode or NessComms.

FACTORY DEFAULT

ON Auto Exclude enabled.

RELATED OPTIONS

P62E 7E Siren burst on Auto Exclude.

P60E 7E

PROGRAM MODE LEVEL

Installer mode or NessComms.

FACTORY DEFAULT

OFF: Display is always ON.

NOTES

- LCD KEYPADS: The LCD display and display backlighting will turn off but the key backlighting will remain on. The keypad flap can be closed to reduce stray light from the keys.

NAVIGATOR KEYPAD: The touch screen display will go blank. Touch to restore.

P60E 8E

PROGRAM MODE LEVEL

Installer mode or NessComms.

FACTORY DEFAULT

OFF: AUX3 & AUX4 outputs are instant.

RELATED OPTIONS

P143E 1E, AUX3 on when Area1 arms.

P143E 2E, AUX3 on when Area2 arms.

P144E 1E, AUX4 on when Area1 arms.

P144E 2E, AUX4 on when Area2 arms.

TAMPER SIREN LOCKOUT

This option programs the Tamper input to Lockout, i.e. cause the Siren & Reset outputs to sound only once while the panel is armed.

PROGRAMMING SEQUENCE:

P60E 4E toggles the option ON and OFF

OFF: Tamper Reset Lockout disabled

ON: Tamper Reset Lockout enabled

DURESS TO RESET OUTPUT

Keypad Duress is normally a silent alarm. This option makes the Duress alarm trigger the Reset output. To Disarm with Duress, add any of the digits 5,6,8 or 9 in front of the user code when Disarming.

PROGRAMMING SEQUENCE:

P60E 5E toggles the option ON and OFF

OFF: No Reset output on Duress alarm

ON: Duress alarm triggers Reset output

AUTO EXCLUDE ZONES

If a zone is unsealed at the end of Exit Time the panel can either Exclude (ignore) that zone or immediately alarm.

The panel will give a 2 second Siren burst at the end of Exit Time to indicate that the panel is armed with a zone/s Auto Excluded. The 2 sec Siren burst can be disabled by option P62E 7E.

PROGRAMMING SEQUENCE:

P60E 6E toggles the option ON and OFF

OFF: Auto Exclude disabled (instant alarm if unsealed at end of Exit Time)

ON: Auto Exclude enabled (zone is excluded if unsealed at end of Exit Time)

DISABLE THE DISPLAY

Keypad displays can be programmed to blank after 4 minutes of no keypad use. Any action that causes a beep will restore the display. (LCD keypads, use the (E) button preferably. Navigator Touch Screen Keypad, touch to restore the display).

PROGRAMMING SEQUENCE:

P60E 7E toggles the option ON and OFF

OFF: Display is always on

ON: Display will blank after 4 minutes

DELAYED AUX3 & AUX4 OUTPUTS

The AUX3 and AUX4 outputs can be programmed to turn on when Areas 1 and 2 are armed. These outputs can be programmed to turn on instantly or at the end of Exit Time.

This option only applies when AUX3 and AUX4 outputs are enabled as Arm1 and Arm2 outputs, (P143E 1E on and P144E 1E on).

PROGRAMMING SEQUENCE:

P60E 8E toggles the option ON and OFF

OFF: AUX3 & AUX4 outputs turn on instantly, (Default).

ON: AUX3 & AUX4 outputs turn on at the end of exit time.

PROGRAMMING

Option No.	Description	Default
P61E	1E Tamper to RESET output	ON
	2E Tamper to STROBE output	ON
	3E Tamper to Keypad Sonalert	ON
	4E Tamper to SIREN output	ON
	5E Keypad Panic to RESET output	ON
	6E Keypad Panic to STROBE output	ON
	7E Keypad Panic to Sonalert	ON
	8E Keypad Panic to SIREN output	ON

P61E 1E-4E

PROGRAM MODE LEVEL

Installer mode or NessComms.

FACTORY DEFAULT

1E-4E, ON: Tamper alarm triggers all outputs.

NOTES

- A Tamper Alarm can be caused by the TAMP input or by removing the the J1 PROG/TAMP link on the main board.

TAMPER ALARM / OUTPUT MAPPING

This option selects which outputs will trigger when a Tamper Alarm occurs.

PROGRAMMING SEQUENCE:

P61E 1E-4E toggles the options ON and OFF

1E ON: Tamper Alarm to Reset output

2E ON: Tamper Alarm to Strobe output

3E ON: Tamper Alarm to Keypad Sonalert output

4E ON: Tamper Alarm to Siren output

P61E 5E-8E

PROGRAM MODE LEVEL

Installer mode or NessComms.

FACTORY DEFAULT

5E-8E, ON: Panic alarm triggers all outputs.

NOTES

- A Keypad Panic Alarm can be caused by the PANIC keys on the keypad (* E or ** together, depending on Option P126E1E).

KEYPAD PANIC ALARM / OUTPUT MAPPING

This option selects which outputs will trigger when a Keypad Panic alarm occurs.

PROGRAMMING SEQUENCE:

P61E 5E-8E toggles the options ON and OFF

5E ON: Keypad Panic Alarm to Reset output

6E ON: Keypad Panic Alarm to Strobe output

7E ON: Keypad Panic Alarm to Keypad Sonalert output

8E ON: Keypad Panic Alarm to Siren output

Option No.	Description	Default	
P62E	1E	Shortcut Memory display	ON
	2E	Shortcut Zone Exclude	ON
	3E	Shortcut Home Mode	ON
	4E	Shortcut Keypad Panic	OFF
	5E	Shortcut Area1 Arming	ON
	6E	Shortcut Area2 Arming	OFF
	7E	Brief warning on Auto Exclude	ON
	8E	Exit Time x10	OFF

P62E 1E-6E

PROGRAM MODE LEVEL

Installer mode or NessComms.

FACTORY DEFAULT

1E, ON: Memory Display shortcut enabled.
 2E, ON: Zone Exclude shortcut enabled.
 3E, ON: Home Mode shortcut enabled.
 4E, OFF: Keypad Panic shortcut disabled.
 5E, ON: Area1 Arming shortcut enabled.
 6E, OFF: Area2 Arming shortcut disabled.

RELATED OPTIONS

P64E 6E STD LCD keypad double key panic.

P126E 1E, 2E, 3E KPX keypad double key keypad functions.

NOTES

If either Area1 or Area2 are armed by shortcut and no user codes are assigned to that Area then it will always remain armed. You will then need to enter program mode on power-up and assign codes to Areas.

P62E 7E

PROGRAM MODE LEVEL

Installer mode or NessComms.

FACTORY DEFAULT

ON: Siren burst on Auto Exclude enabled.

RELATED OPTIONS

P60E 6E Auto Exclude zones.

P62E 8E

PROGRAM MODE LEVEL

Installer mode or NessComms.

FACTORY DEFAULT

OFF: Exit Time x10 disabled.

RELATED OPTIONS

P28E Exit Time.

SYSTEM OPERATION SHORTCUTS

Some keypad operations can be programmed to operate with or without a User Code.

PROGRAMMING SEQUENCE:

P62E 1E-6E toggles the options ON and OFF

1E ON: Memory Display shortcut
 2E ON: Zone Exclude shortcut
 3E ON: Home Mode shortcut
 4E ON: Keypad Panic shortcut
 5E ON: Area1 Arming shortcut
 6E ON: Area2 Arming shortcut

OPERATING EXAMPLES:

Arming without shortcut: **ARM** [User Code] **E**

Arming with shortcut: **ARM** **E**

Keypad Panic without shortcut: ***** [User Code] **E**

Keypad Panic with shortcut: ***** **E**

NOTE: ***** [User Code] **E** always triggers Keypad Panic.

KPX LCD KEYPAD, see option P64E 6E to enable Double Key Panic.

STD LCD KEYPAD, see option P126E 1E to enable Double Key Panic.

SIREN BURST ON AUTO EXCLUDE

This option allows the disabling of the 2 second siren burst at the end of Exit Time which indicates a zone/s has been Auto Excluded.

PROGRAMMING SEQUENCE:

P62E 7E toggles the option ON and OFF

OFF: Siren burst on Auto Exclude disabled

ON: Siren burst on Auto Exclude enabled

EXIT TIME X10

This option multiplies the normal exit time by a factor of 10.

PROGRAMMING SEQUENCE:

P62E 8E toggles the option ON and OFF

OFF: Exit Time is the time set by P28E

ON: Exit Time is multiplied by 10

EXAMPLE: If P28E = 22 seconds then if P62E 8E is ON, the exit time is 22 x 10 = 220 seconds.

PROGRAMMING

Option No.	Description	Default	
P63E	1E	Home Mode alarms to RESET output	ON
	2E	Home Mode alarms to STROBE	ON
	3E	Home Mode alarms to SONALERT	ON
	4E	Home Mode alarms to SIREN	OFF
	5E	Day Mode to RESET output	ON
	6E	Day Mode to STROBE	OFF
	7E	Day Mode to keypad SONALERT	OFF
	8E	Day Mode to SIREN	OFF

P63E 1E-4E

PROGRAM MODE LEVEL

Installer mode or NessComms.

FACTORY DEFAULT

1E, 2E, 3E ON.
4E OFF.

RELATED OPTIONS

P64E 1E Brief Home alarm.

HOME MODE OUTPUT MAPPING

This option selects which outputs are triggered by alarms in Home Mode.

PROGRAMMING SEQUENCE:

P63E 1E-4E toggles the options ON and OFF

1E ON: Home Mode to Reset output
2E ON: Home Mode to Strobe output
3E ON: Home Mode to Keypad Sonalert output
4E ON: Home Mode to Siren output

P63E 5E-8E

PROGRAM MODE LEVEL

Installer mode or NessComms.

FACTORY DEFAULT

5E ON.
6E, 7E, 8E OFF.

RELATED OPTIONS

P64E 2E Brief Day alarm.

DAY MODE OUTPUT MAPPING

This option selects which outputs are triggered by alarms in Day Mode.

PROGRAMMING SEQUENCE:

P63E 5E-8E toggles the options ON and OFF

5E ON: Day Mode to Reset output
6E ON: Day Mode to Strobe output, (If Brief Day Alarm is enabled, (P64E 2E), then this option sends day alarms to the AUX2 output).
7E ON: Day Mode to Keypad Sonalert output
8E ON: Day Mode to Siren output

For ZONE TO OUTPUT MAPPING for armed & 24hr states – see options P54E – P59E, page 22-23.

Option No.	Description	Default	
P64E	1E	Brief Home Alarm	OFF
	2E	Brief Day Alarm	OFF
	3E	Home zones Entry Delay2	ON
	4E	Radio Key SIREN CHIRPS	OFF
	5E	[not used]	ON
	6E	Strobe Flash on Home arm by radio	OFF
	7E	[not used]	OFF
	8E	[not used]	OFF

P64E 1E

PROGRAM MODE LEVEL

Installer mode or NessComms.

FACTORY DEFAULT

OFF: Brief Home Alarm disabled.

RELATED OPTIONS

P51E Set Home zones.

P63E 1E–4E Home Mode output mapping

BRIEF HOME MODE ALARM

Alarms in Home Mode can either activate the programmed outputs for Siren Time duration (P29E) or they can activate the outputs for 2 seconds only.

NOTE: If Brief Home alarm is enabled, then Home alarms will not be reported by dialler.

PROGRAMMING SEQUENCE:

P64E 1E toggles the option ON and OFF

OFF: Home Mode outputs have normal time as set by P29E

ON: Home Mode outputs are ON for 2 seconds only

P64E 2E

PROGRAM MODE LEVEL

Installer mode or NessComms.

FACTORY DEFAULT

OFF: Brief Day Alarm disabled.

RELATED OPTIONS

P53E Assign Day zones.

P63E 5E–8E Day Mode output mapping.

BRIEF DAY ALARM

Alarms in Day Mode will activate the programmed outputs while the zone is unsealed or they can activate the outputs for 2 seconds only.

This option also enables the TEMPORARY DAY ZONE feature. See page 20.

PROGRAMMING SEQUENCE:

P64E 2E toggles the option ON and OFF

OFF: Brief Day Alarm disabled. Day alarm outputs are ON while the zone is unsealed

ON: Brief Day Alarm Enabled. Day alarm outputs are ON for 2 seconds only

P64E 3E

PROGRAM MODE LEVEL

Installer mode or NessComms.

FACTORY DEFAULT

ON: Home zones all have Entry Delay2.

RELATED OPTIONS

P27E Entry Delay Time 2.

P51E Assign Home zones.

P63E 1E–4E Home Mode output mapping.

HOME ZONES ENTRY DELAY 2

Home zones can either have the delay types set by options P40E–P43E or they can all be assigned to have Entry Delay 2. This allows all Home zones to be programmed with the same entry delay time.

PROGRAMMING SEQUENCE:

P64E 3E toggles the option ON and OFF

OFF: Home zones behave as programmed by P40E–P43E

ON: Home zones all have Entry Delay 2

P64E 4E

PROGRAM MODE LEVEL

Installer mode or NessComms.

FACTORY DEFAULT

OFF: No siren chirps.

RELATED OPTIONS

P68E 8E Quiet Chirps.

P69E 5E Home Arm by Radio Key.

P120E 2E Home Arm chirps.

P120E 3E Radio Key AUX button arms Home Mode.

ARM/DISARM CHIRPS

If this option is selected the Siren output will "Chirp" when the panel is armed and disarmed with the Keyswitch input, prox cards or Radio Keys. This option applies to *siren chirps*, the *strobe* output always flashes when arming/disarming by the above methods. (Home arming chirps are enabled separately by option P120E 2E).

The siren output will make 1 Chirp on Arming, and 3 Chirps on Disarming.

PROGRAMMING SEQUENCE:

P64E 4E toggles the option ON and OFF

OFF: No Arm/Disarm siren chirps

ON: Siren & Strobe outputs will chirp on arm/disarm

PROGRAMMING

P64E 6E

PROGRAM MODE LEVEL

Installer, Remote by PC.

FACTORY DEFAULT

OFF: No strobe.

NOTES

This is not related to strobe flash on arming and disarming area 1 or 2 by radio key, which always flashes the strobe on arm and disarm.

RELATED OPTIONS

P69E 5E Home Mode arming by radio key.

P120E 2E Siren Chirp on Home Arming by Radio

STROBE FLASH ON HOME ARMING BY RADIO

This option enables a brief strobe flash when arming Home Mode by radio key or radio keypad. This applies to Home Mode arming only, disarming Home Mode by radio key never flashes the strobe.

PROGRAMMING SEQUENCE:

P64E 6E *toggles the option ON and OFF*

OFF: No strobe flash

ON: Strobe flash enabled

Option No.	Description	ZONES 1–8 (D8 & D16)								ZONES 9–16 (D16)							
		1	2	3	4	5	6	7	8	9	10	11	12	13	14	15	16
P65E	SUPERVISED ZONES																

P65E

PROGRAM MODE LEVEL

Installer mode or NessComms.

FACTORY DEFAULT

all OFF: No Supervision zones.

RELATED OPTIONS

P66E 1E–4E Supervision Alerts.

P66E 5E Wired Zone Supervision.

P67E Zone Supervision Time.

P92E 4E (D8) Report Supervision.

P75E 12E (D16) Report Supervision.

NOTES

0E will turn all selections OFF.

MEMORY E will turn all selections ON.

If Radio Supervision is enabled, P66E 5E off, then the supervision feature cannot be used as an inactivity monitor.

SUPERVISED ZONES

Any zone 1-8 or 1-16 can be a Supervised Zone.

Supervision for HARDWIRED ZONES

In operation, a Supervised Zone is subject to the Supervision Time (P67E). If the zone/s has not sealed or unsealed during the Supervision Time, then the programmed alerts will turn on (as programmed by P66E 1E-4E, P92E 4E or P75E 12E). Zone Supervision can be used as an "inactivity monitor" to sound an alert or send a dialler report if a zone has had no activity during a set period of time. (For example, to monitor an aged person's home).

- A zone which is permanently in a sealed or unsealed state for the duration of Supervision Time will be treated as a Supervision alarm.
- If P66E 5E is on, Zone Supervision acts on wired zones. If P66E 5E is off, Zone Supervision acts on radio zones.
- Each Supervised zone has its own supervision timer.
- Zone Supervision is independent of the armed state of the panel.
- Zone Supervision can be temporarily disabled by Excluding the zone/s.
- The zone which caused the Supervision alarm flashes on the keypad. Entering a valid code + E will reset Supervision alarms.

Supervision for RADIO ZONES

The purpose of Radio Supervision is to verify the correct operation of Ness Radio PIRs. The Supervision signal from the Radio PIR tells the panel that the device has not been removed from radio range and is in working order.

A non-SUPERVISION enabled Radio PIR will transmit signals to the panel only when it has detected an event. Obviously, there is no guaranteed signal period.

In either case, when the allowed time limit is exceeded then a WARNING is first given (if programmed by P66E 3E), and then after 1 minute, the programmed RADIO SUPERVISION ALERTS are generated by the panel.

P66E 5E must be off for supervision to work on radio zones.

PROGRAMMING SEQUENCE:

P65E [Zone No]E toggles the options ON and OFF

[Zone No]E OFF: The zone is not a Supervised Zone

[Zone No]E ON: The zone is a Supervised Zone

PROGRAMMING

Option No.	Description	Default	
P66E	1E	Zone Supervision alarm to RESET output	OFF
	2E	Zone Supervision alarm to STROBE	OFF
	3E	Zone Supervision alarm to SONALERT	OFF
	4E	Zone Supervision alarm to SIREN	OFF
	5E	Enable WIRED ZONE supervision	OFF
	6E		OFF
	7E	Zone Supervision speedup x 6	OFF
	8E	Zone Supervision speedup x10	OFF

P66E 1E

PROGRAM MODE LEVEL

Installer mode or NessComms.

FACTORY DEFAULT

OFF: Supervision Reset output disabled.

RELATED OPTIONS

P65E Supervised Zones.

ZONE SUPERVISION ALERTS – RESET OUTPUT

Setting this option turns the Reset output ON when a SUPERVISED ZONE alert occurs. The Reset output will remain ON for the duration of the ALARM TIME (Set by Option P29E).

PROGRAMMING SEQUENCE:

P66E 1E toggles the option ON and OFF

OFF: Supervision Reset output disabled

ON: Supervision Reset output enabled

P66E 2E

PROGRAM MODE LEVEL

Installer mode or NessComms.

FACTORY DEFAULT

OFF: Supervision Strobe output disabled.

RELATED OPTIONS

P65E Supervised Zones.

ZONE SUPERVISION ALERTS – STROBE OUTPUT

Setting this option turns the Strobe output ON when a SUPERVISED ZONE alert occurs. The Strobe output will remain ON until the panel is disarmed.

PROGRAMMING SEQUENCE:

P66E 2E toggles the option ON and OFF

OFF: Supervision Strobe output disabled

ON: Supervision Strobe output enabled

P66E 3E

PROGRAM MODE LEVEL

Installer mode or NessComms.

FACTORY DEFAULT

OFF: Supervision Keypad Sonalert disabled.

NOTES

- When this option is turned ON, it delays the operation of all other selected Supervision outputs by one minute.

RELATED OPTIONS

P65E Supervised Zones.

ZONE SUPERVISION ALERTS – KEYPAD SONALERT

Setting this option turns the Keypad Sonalert ON when a SUPERVISED ZONE alert occurs. The Keypad Sonalert remains ON until any keypad key is pressed.

Also, turning this option ON makes all Supervision outputs delayed by one minute.

PROGRAMMING SEQUENCE:

P66E 3E toggles the option ON and OFF

OFF: Supervision Keypad Sonalert disabled and all Supervision outputs trigger instantly

ON: Supervision Keypad Sonalert enabled and all Supervision outputs are delayed by 1 minute

P66E 4E

PROGRAM MODE LEVEL

Installer mode or NessComms.

FACTORY DEFAULT

OFF: Supervision Siren output disabled.

RELATED OPTIONS

P65E Supervised Zones.

ZONE SUPERVISION ALERTS – SIREN OUTPUT

Setting this option turns the Siren output ON when a SUPERVISED ZONE alert occurs. The Siren output will remain ON for the duration of the ALARM TIME (Set by Option P29E).

PROGRAMMING SEQUENCE:

P66E 4E toggles the option ON and OFF

OFF: Supervision Siren output disabled

ON: Supervision Siren output enabled

P66E 5E

THIS OPTION IS AVAILABLE IN D8X/D16X V5.2 AND LATER

PROGRAM MODE LEVEL

Installer mode or NessComms.

FACTORY DEFAULT

OFF: Radio Zone Supervision enabled.

RELATED OPTIONS

P65E Supervised Zones.
 P66E 1E–4E Supervision Alerts.
 P66E 5E Wired Zone Supervision.
 P67E Zone Supervision Time.
 P92E 4E (D8) Report Supervision.
 P75E 12E (D16) Report Supervision.

P66E 7E

PROGRAM MODE LEVEL

Installer mode or NessComms.

FACTORY DEFAULT

OFF: Supervision Time normal.

RELATED OPTIONS

P67E Supervision Time.
 P66E 8E Supervision Time speedup x10.

P66E 8E

PROGRAM MODE LEVEL

Installer mode or NessComms.

FACTORY DEFAULT

OFF: Supervision Time normal.

RELATED OPTIONS

P67E Supervision Time.
 P66E 7E Supervision Time speedup x6.

P67E

PROGRAM MODE LEVEL

Installer mode or NessComms.

FACTORY DEFAULT

24 hours or 24 minutes.

NOTES

- Supervision time for wired or wireless zones must be 2 minutes or greater for correct operation.
- A setting of less than 3 hours for radio supervision is not recommended.
- The Supervision timer is reset on exit from Installer Program Mode and on Arm or Disarm.

RELATED OPTIONS

P65E Supervised Zones.
 P66E 1E–4E Supervision Alerts.
 P66E 7E–8E Supervision Time Speed-up.

ENABLE WIRED ZONE SUPERVISION

This option enables Wired Zone Supervision or Radio Zone Supervision.

PROGRAMMING SEQUENCE:

P66E 5E toggles the option ON and OFF

OFF: Radio Zone Supervision enabled

ON: Wired Zone Supervision enabled

SUPERVISION TIME SPEEDUP X6

Setting this option speeds up the Supervision Time by 6. For instance if P67E is set to 1 hour (60 minutes), then this option will reduce it to 10 minutes. (i.e., 60 divided by 6).

PROGRAMMING SEQUENCE:

P66E 7E toggles the option ON and OFF

OFF: Supervision Time normal as set by P67E

ON: Supervision Time speedup x6

SUPERVISION TIME SPEEDUP X10

Setting this option speeds up the Supervision Time by 10. For instance if P67E is set to 1 hour (60 minutes), then this option will reduce it to 6 minutes. (i.e., 60 divided by 10).

PROGRAMMING SEQUENCE:

P66E 8E toggles the option ON and OFF

OFF: Supervision Time normal as set by P67E

ON: Supervision Time speedup x10

NOTE: If both P66E 7E and 8E are both ON then the Supervision time is sped up by 60. For instance if P67E is set to 1 hour (60 minutes), then this option will reduce it to 1 minute. (i.e., 60 divided by 60).

SUPERVISION TIME

SUPERVISION TIME sets the time interval before an inactive Supervised Zone triggers a Supervision alarm.

The SUPERVISION TIME setting is from 01 to 24 hours.

For timing up to 24 minutes, set P66E 7E & 8E on.

For timing up to 24 hours, set P66E 7E & 8E off.

PROGRAMMING SEQUENCE:

P67E existing time is displayed one digit at a time

[ENTER NEW TIME] E new time is displayed one digit at a time

EXAMPLE: To program SUPERVISION TIME to be 4 hours:

P67E 04E

PROGRAMMING

Option No.	Description	Default	
P68E	1E	Double Press Radio Panic	OFF
	2E	Auto Re-Arm	OFF
	3E	Long Radio Message	ON
	4E	"OK/READY" Display	OFF
	5E	Radio Arming "unsealed" warning	OFF
	6E	24hr Zone Fire Siren sound	OFF
	7E	Single Shot strobe on Arm by R/Key	OFF
	8E	Quiet chirps on radio Arm/Disarm	OFF

P68E 1E

Available in D8x/D16x V6 and later.

PROGRAM MODE LEVEL

Installer mode or NessComms.

FACTORY DEFAULT

OFF: Single Press Radio Panic.

DOUBLE PRESS RADIO PANIC

Setting this option ON enables Double Press Panic for Ness Radio Keys, if fitted. The panel will look for two radio Panic signals in a row to sound the Panic alarm.

OPERATION. On the Radio Key, press and hold Panic until the transmit LED turns on. Wait until the LED turns off then release the Panic button and immediately press and hold again until the transmit LED turns on a second time.

This requirement meets regulations in some states of Australia.

PROGRAMMING SEQUENCE:

P68E 1E toggles the option ON and OFF

OFF: Single Press Radio Panic

ON: Double Press Radio Panic

P68E 2E

Available in D8x/D16x V6 and later.

PROGRAM MODE LEVEL

Installer mode or NessComms.

FACTORY DEFAULT

OFF: Auto Re-Arm disabled.

NOTES

- Auto re-arm will not take place if the panel is disarmed during the exit delay time. This allows you to disarm immediately if you change your mind about leaving the premises.
- Auto re-arm operates independently on both Areas 1 and 2.

RELATED OPTIONS

P26E Entry Delay Time1 sets the "time before re-arming".

For example, say P26E is 30sec, if you disarm the panel and do not enter the premises, then the panel will Auto Re-arm in 30 seconds.

AUTO RE-ARM

Auto Re-Arm checks that you have entered the premises after disarming.

After disarming, the panel will wait for the same time set for Entry Delay. If all zones remain sealed the panel will re-arm. This is most useful when used with radio keys where the OFF button might be accidentally pressed after you have armed and are leaving the premises.

PROGRAMMING SEQUENCE:

P68E 2E toggles the option ON and OFF

OFF: Auto Re-Arm disabled

ON: Auto Re-Arm enabled

P68E 3E

Available in D8x/D16x V5.6 and later.

PROGRAM MODE LEVEL

Installer mode or NessComms.

FACTORY DEFAULT

ON: Long Radio Message.

NOTE

Some models of Ness detectors and radio keys without encryption will not work with this setting on.

If a radio device is not recognised when you try to program it on this control panel, try turning this option off.

LONG RADIO MESSAGE

Setting this option ON enables Long Radio Message for Radio Keys and Radio Devices. Radio detectors will now need the encryption link turned on. Enabling Long Radio Message gives greater protection against coding clashes with third party radio signals.

PROGRAMMING SEQUENCE:

P68E 3E toggles the option ON and OFF

OFF: Normal Radio Message

ON: Long Radio Message

P68E 4E

Available in D8x/D16x V6 and later.

PROGRAM MODE LEVEL

Installer mode or NessComms.

FACTORY DEFAULT

OFF: OK/READY ignores delay zones.

P68E 5E

PROGRAM MODE LEVEL

Installer mode or NessComms.

FACTORY DEFAULT

OFF: Radio Key siren warning disabled.

NOTES

Unsealed zone warning is inactive if P64E 4E Arm/Disarm Chirps is enabled regardless of the status of P68E 5E.

P68E 6E

PROGRAM MODE LEVEL

Installer mode or NessComms.

FACTORY DEFAULT

OFF: No 24hr Fire siren sound.

P68E 7E

Available in D8x/D16x V6 and later.

PROGRAM MODE LEVEL

Installer mode or NessComms.

FACTORY DEFAULT

OFF: Strobe Flash on very ARM signal.

P68E 8E

PROGRAM MODE LEVEL

Installer mode or NessComms.

FACTORY DEFAULT

OFF: Quiet Chirps disabled.

RELATED OPTIONS

P64E 4E Radio Key Chirps.
 P69E 5E Home Arm by Radio Key.
 P120E 2E Home Arm chirps.
 P120E 3E Radio Key AUX / arms Home Monitor
 P162E Chirp Siren Volume

"OK/READY" DISPLAY OPTION

When the option is OFF, the OK/READY icon will display even if Entry Delay zones are unsealed. This is useful in cases where the keypad location is covered by a PIR with entry delay.

When this option is ON, all zones including Entry Delay zones must be sealed for the keypad/s to display the OK/READY icon.

PROGRAMMING SEQUENCE:

P68E 4E toggles the option ON and OFF

OFF: OK/READY ignores delay zones (default)

ON: OK/READY senses all zones

RADIO KEY ARMING, UNSEALED ZONE WARNING

Setting this option ON allows a 2 second SIREN warning if there is an unsealed zone in an Area Armed by a Radio Key.

PROGRAMMING SEQUENCE:

P68E 5E toggles the option ON and OFF

OFF: Radio Key arming, siren warning disabled

ON: Radio Key arming, siren warning enabled

24HR ZONE FIRE SIREN SOUND

This option changes the siren sound when a 24hr zone is triggered. The keypad key sequence for FIRE (3 E) always outputs the FIRE siren sound.

PROGRAMMING SEQUENCE:

P68E 6E toggles the option ON and OFF

OFF: Fire siren sound disabled

ON: Fire siren sound enabled

SINGLE SHOT STROBE ON ARMING

This option provides a choice of operation for the strobe flash when arming by a Radio Key.

When this option is OFF the strobe will flash every time an ARM signal is received from a valid Radio Key. If the panel is armed any subsequent ARM signals will flash the strobe light. The panel will not change state because it already armed.

When this option is ON the strobe will flash only when the panel arms. Any subsequent ARM signals will be ignored.

PROGRAMMING SEQUENCE:

P68E 7E toggles the option ON and OFF

OFF: Strobe flashes on every ARM signal

ON: Single Shot Strobe flashes only on panel Arming

QUIET CHIRPS ON ARM/DISARM

This quietyens the siren chirps that are made whenever keyswitch or radio key Arming or Disarming is used.

(Arm/Disarm Chirps must be enabled at P64E 4E).

PROGRAMMING SEQUENCE:

P68E 8E toggles the option ON and OFF

OFF: Quiet Chirps disabled

ON: Quiet Chirps enabled

PROGRAMMING

Option No.	Description	Default	
P69E	1E	Flash strobe on medical alert	OFF
	2E	[not used]	OFF
	3E	Quiet Home Siren	OFF
	4E	6 beeps on Arming	OFF
	5E	Home arm by radio key ON/OFF	OFF
	6E	Disable Mains Fail Alarm	OFF
	7E	Exit BEEPS - Full Arm	OFF
	8E	Exit BEEPS - Home Mode	OFF

P69E 1E

PROGRAM MODE LEVEL

Installer mode or NessComms.

FACTORY DEFAULT

OFF

RELATED OPTIONS

P64E 8E Enable medical alarm.

FLASH STROBE ON MEDICAL ALARM

This option enables the strobe output when a medical alarm is triggered. This is to make the house visible to the ambulance. The strobe will reset after 72 hours or when a valid code is entered.

PROGRAMMING SEQUENCE:

P69E 3E toggles the option ON and OFF

OFF: Strobe does not flash on medical alarm

ON: Strobe flashes on medical alarm

P69E 3E

PROGRAM MODE LEVEL

Installer mode or NessComms.

FACTORY DEFAULT

OFF: Normal siren sound in Home Mode.

NOTES

This does not affect the RESET output.

QUIET HOME SIREN

This option selects the 'Quiet Siren' sound in Home Mode. The Quiet Siren sound is a continuous "beep beep beep" sound rather than the normal siren sound.

PROGRAMMING SEQUENCE:

P69E 3E toggles the option ON and OFF

OFF: Normal siren sound in Home Mode

ON: Quiet Siren sound in Home Mode

P69E 4E

PROGRAM MODE LEVEL

Installer mode or NessComms.

FACTORY DEFAULT

OFF: Keypad gives 3 beeps on Arming.

NOTES

The keypad beeps on Arm/Disarm when Arming/Disarming by keypad, keyswitch or by Radio Key.

6 BEEPS ON ARMING

Normally the keypad/s onboard SONALERT gives 3 beeps when the panel is armed. Turning this option ON will give 6 keypad beeps when Arming.

PROGRAMMING SEQUENCE:

P69E 4E toggles the option ON and OFF

OFF: Keypad gives 3 beeps on Arming

ON: Keypad gives 6 beeps on Arming

P69E 5E

PROGRAM MODE LEVEL

Installer mode or NessComms.

FACTORY DEFAULT

OFF: Radio Keys cannot Arm Home Mode.

NOTES

- Radio Key Home Arming will work only if one or more zones have been programmed as Home Zones (P51E).
- When using a Radio Keypad to Home arm, ensure that the ARM ONLY option is OFF for the USER CODE on the panel. Otherwise further Home E keypresses on the Radio keypad could AREA arm the panel.

RELATED OPTIONS

P51E Program Home zones.
 P64E 1E Brief Home alarm.
 P64E 6E Strobe Flash on Home arm by radio key
 P69E 3E Quiet Home siren.
 P69E 5E Home Arm by Radio Key.
 P120E 2E Home arm chirps by Radio Key.
 P120E 3E Radio Key AUX arms Home Monitor.
 P120E 6E Smart Beeps.

P69E 6E

PROGRAM MODE LEVEL

Installer mode or NessComms.

FACTORY DEFAULT

OFF: Mains Fail alarm normal.

NOTES

This does not affect Dialler mains fail reporting or saving to the History memory or operation of the Mains Fail output on the Output Expander.

Does not apply to Navigator keypad.

P69E 7E

Available in D8x/D16x V5.7 and later.

PROGRAM MODE LEVEL

Installer mode or NessComms.

FACTORY DEFAULT

Exit Beeps OFF.

RELATED OPTIONS

P28E Exit Delay Time.

P69E 8E

Available in D8x/D16x V5.7 and later.

PROGRAM MODE LEVEL

Installer mode or NessComms.

FACTORY DEFAULT

Home Exit Beeps OFF.

RELATED OPTIONS

P28E Exit Delay Time.

HOME ARMING BY RADIO KEY ON/OFF BUTTONS

Setting this option on allows Home Mode arming by Radio Key ON or OFF buttons.
 Note: This is independent of Home arming by AUX button if using the RK4 radio key.

PROGRAMMING SEQUENCE:

P69E 5E toggles the option ON and OFF

OFF: Radio Key Home Mode Arming disabled

ON: Radio Key Home Mode Arming enabled

OPERATION:

- Press the Radio Key OFF button twice within 4 seconds.
- or.... - Press the Radio Key ON button twice within 5 seconds.

See page 20 for Home operation.

DISABLE MAINS FAIL ALARM

When set ON, a Mains Fail alarm is: 1. Not displayed on the keypad, 2. Does not give warning beeps, 3. Is not saved to MEMORY and the MEMORY display does not flash.

PROGRAMMING SEQUENCE:

P69E 6E toggles the option ON and OFF

OFF: Mains Fail alarm operates normally

ON: Mains Fail alarm is disabled

BEEPS DURING EXIT DELAY - FULLY ARMED MODE

This option gives an audible warning during Exit Delay.

The sonalert will beep slowly during Exit Delay when the panel is in exit delay (armed by any Area). When the Exit Time has 16 to 20 seconds remaining, the beeps will change to a faster double-beep for the remainder of the Exit Time. The end of Exit Time is announced by 3 beeps.

PROGRAMMING SEQUENCE:

P69E 7E toggles the option ON and OFF

OFF: Exit Beeps OFF

ON: Exit Beeps ON

BEEPS DURING EXIT DELAY - HOME MODE

This option gives an audible warning during Exit Delay.

The sonalert will give a fast double-beep during Exit Delay when the panel is in Home Mode Exit Delay. The end of Exit Time is announced by 3 beeps.

PROGRAMMING SEQUENCE:

P69E 8E toggles the option ON and OFF

OFF: Home Exit Beeps OFF

ON: Home Exit Beeps ON

NOTES:

1. Exit beeps cannot be stopped (i.e. by pressing a key on the keypad).
2. If another event causes a different keypad beep, the exit beeps resume once the event beeps are finished.

PROGRAMMING

Option No.	Description	Default
P00E	FOLLOW-ME TELEPHONE NUMBER - For audible dialling	
P70E	TELEPHONE NUMBER 1 - PRIMARY	
P71E	TELEPHONE NUMBER 2 - SECONDARY	
P80E	TELEPHONE NUMBER 3 - TEST CALLS	
P81E	TELEPHONE NUMBER 4 - CALLBACK FOR UPLOAD	
P72E	ACCOUNT NUMBER 1	0000
P73E	ACCOUNT NUMBER 2	0000

P00E

PROGRAM MODE LEVEL

User, Installer mode or NessComms.

FACTORY DEFAULT

No telephone numbers.

NOTES

- If the Follow Me telephone number is disabled, all audible format calls are made on telephone numbers 1 & 2.

RELATED OPTIONS

P86E 2E Contact ID format (Back to base monitoring).

P86E 4E Audible format.

P86E 6E Contact ID + Audible Pulse.

FOLLOW ME TELEPHONE NUMBER

The Follow Me telephone number is only used in Audible Dialling mode. (If P86E 4E or 6E are on).

The Follow Me telephone number can be programmed in User Program Mode. If the Follow Me number is programmed, then the primary & secondary numbers are ignored.

IF P86E 4E IS ENABLED (AUDIBLE MONITORING)

In this case, if the Follow Me number is programmed, the primary & secondary numbers are ignored.

IF P86E 6E IS ENABLED (CONTACT ID + AUDIBLE)

The telephone numbers programmed at P70E & P71E will be used to send the message to the central station. The message is also repeated in audible format to the telephone number (if any) programmed at P00E.

PROGRAMMING SEQUENCE:

P00E existing telephone number is displayed one digit at a time

[ENTER NEW TELEPHONE No] E new telephone number is displayed one digit at a time

P70E, P71E

PROGRAM MODE LEVEL

Installer mode or NessComms.

FACTORY DEFAULT

No telephone numbers.

NOTES

- If telephone number 2 is disabled, all calls are made on telephone number 1 and the setting of P87E 1E has no effect.

- If telephone number 3 is disabled, all test calls are made on telephone number 1&2

- Any keypress will stop the telephone number display sequence.

RELATED OPTIONS

P87E 1E Alternate Primary/Secondary telephone numbers.

P86E 1E Disable dialler (still allows remote up/download if programmed).

TELEPHONE NUMBERS 1 & 2

The panel can dial up to 2 phone numbers when an event is to be transmitted to a central monitoring station or other location. Telephone numbers may be up to 30 digits in length.

PROGRAMMING SEQUENCE:

P70E existing telephone number is displayed one digit at a time

[ENTER NEW TELEPHONE No] E new telephone number is displayed one digit at a time

EXAMPLE: To program Telephone No.1 to be 03 1234 1234:

P 70 E 0312341234 E

TO CLEAR A TELEPHONE NUMBER

To clear a telephone number, enter the MEMORY key in place of the telephone number. Example, to clear a Telephone Number 1 press: P70E MEMORY E

SPECIAL CHARACTERS (Applies to all telephone Numbers)

If required, pauses, * (star) or # (hash) VF digits can be included in the dialling sequence by using the keys in the table below.

SPECIAL CHARACTER	KEY ENTRY	KEYPAD DISPLAY
PAUSE (1.6sec)	ARM Key	12
* (Star)	HOME Key	10
# (Hash)	EXCLUDE Key	11

P72E, P73E

PROGRAM MODE LEVEL

Installer mode or NessComms.

FACTORY DEFAULT

P72E Account No.1: 0000

P73E Account No.2: 0000

RELATED OPTIONS

P79E Account No.2 zones

ACCOUNT NUMBER 1 & 2

Account numbers for identifying the panel to the Central Station. Area 1 Open/Close reports will report on Account No.1 and Area 2 Open/Close reports will report on Account No.2.

Zone Alarms can be assigned to report on either Account Number as set by Option P79E.

All miscellaneous events (eg. Tamper, Mains Fail) will report on Account No. 1.

PROGRAMMING SEQUENCE:

P72E (or P73E) existing account number is displayed one digit at a time

[ENTER NEW ACCOUNT No] E new account number is displayed one digit at a time

EXAMPLE: To program Account No.1 to be 1239:

P72E1239E

NOTES

Note 1: If using the Ness LED keypad for programming, the Hex digits will not be displayed but are still programmed.

Note 2: Hex digit A is not allowed.

Note 3: Entering Hex digits by keypad applies to D8/D16 V4.6 and later or previous versions by using NessComms download software V4.62 or later.

HEX ACCOUNT NUMBERS

Dialler client codes can now be entered in Hexadecimal - as required by some central stations. Use the following keys to enter the hex digits B, C, D, E or F.

HEX DIGIT	KEY ENTRY	DISPLAYED ON LCD DISPLAY
B	* Key	11
C	ARM Key	12
D	HOME Key	13
E	EXCLUDE Key	14
F	MEMORY key	15

P80E

PROGRAM MODE LEVEL

Installer mode or NessComms.

FACTORY DEFAULT

No telephone numbers.

RELATED OPTIONS

P89E 1E Enable test calls.

P83E Test call interval.

P84E Test call start delay.

TELEPHONE NUMBER 3 – TEST CALLS

Phone Number 3 is used to send Test Calls. If it is not programmed then Test Calls are sent using Telephone No 1 & 2.

PROGRAMMING SEQUENCE:

P80E existing telephone number is displayed one digit at a time

[ENTER NEW TELEPHONE No] E new telephone number is displayed one digit at a time

EXAMPLE: To program Telephone No.3 to be 03 2468 1234:

P80E0324681234E

P81E

PROGRAM MODE LEVEL

Installer mode or NessComms.

FACTORY DEFAULT

No telephone numbers.

RELATED OPTIONS

P90E 8E Enable Callback.

TELEPHONE NUMBER 4 – CALLBACK

Phone Number 4 is used to prevent unauthorised up/download.

The panel will dial the callback telephone number to commence a NessComms™ up/download session.

NessComms™ up/download without callback is allowed by turning off option P90E 8E.

PROGRAMMING SEQUENCE:

P81E existing telephone number is displayed

[ENTER NEW TELEPHONE No] E new Telephone No.4 is displayed one digit at a time

PROGRAMMING

Option No.	Description	ZONES 1-8 (D8 & D16)								ZONES 9-16 (D16)							
		1	2	3	4	5	6	7	8	9	10	11	12	13	14	15	16
P74E	REPORT ZONE ALARMS	ON	ON	ON	ON	ON	ON	ON	ON	ON	ON	ON	ON	ON	ON	ON	ON
P76E	REPORT ZONE RESTORALS	ON	ON	ON	ON	ON	ON	ON	ON	ON	ON	ON	ON	ON	ON	ON	ON
P78E	MULTIPLE ZONE ALARMS																
P79E	ACCOUNT NUMBER 2 ZONES																

P74E

PROGRAM MODE LEVEL
Installer mode or NessComms.

FACTORY DEFAULT
All zones report Alarms.

NOTES
• 0E will turn all selections OFF.
MEMORY E will turn all selections ON.

REPORT ZONE ALARMS

This option selects which zone inputs will send Alarm reports to the Central Station.

PROGRAMMING SEQUENCE:

P74E [Zone No]E toggles the option ON and OFF
[Zone No]E OFF: Alarm reporting disabled for that zone
[Zone No]E ON: Alarm reporting enabled for that zone

P76E

PROGRAM MODE LEVEL
Installer mode or NessComms.

FACTORY DEFAULT
All zones report Restorals.

NOTES
• 0E will turn all selections OFF
MEMORY E will turn all selections ON

RELATED OPTIONS
P82E 1E Send Restoral immediately.
P82E 2E Send Restoral after siren time.
P82E 3E Send Restoral on Disarm & seal.
P82E 4E Send Restoral on Disarm always.

REPORT ZONE RESTORALS

This option selects which zone inputs will send Restoral reports to the Central Station. Only zones that have previously sent an Alarm will send a Restoral.

PROGRAMMING SEQUENCE:

P76E [Zone No]E toggles the option ON and OFF
[Zone No]E OFF: Restoral reporting disabled for that zone
[Zone No]E ON: Restoral reporting enabled for that zone

| Note that Zone Restorals are automatically turned off when P86E 4E Audible
 | Voice Format (AVF) is enabled.
 | Zone Restorals do not revert to default when AVF is disabled and must be
 | manually reprogrammed if required.
 | See P86E 4E, page 44.

P78E

PROGRAM MODE LEVEL
Installer mode or NessComms.

FACTORY DEFAULT
No zones report Multiple Alarms.

NOTES
• Only zones that have previously sent an Alarm will send a Restoral.
• 0E will turn all selections OFF
MEMORY E will turn all selections ON

RELATED OPTIONS
P89E 4E Swinger shutdown.

REPORT MULTIPLE ZONE ALARMS

Zones selected for Multiple Zone Alarms will report each time the zone alarms and without a restore being sent. The number of reports is a maximum of 15. The number of alarms sent for each Multiple Zone Alarm can be reduced to 3 by using the swinger shutdown option P89E 4E.

Zones not selected report only once, until reset by an opening or a valid code.

PROGRAMMING SEQUENCE:

P78E [Zone No]E toggles the option ON and OFF
[Zone No]E OFF: Multiple Zone Alarms disabled for that zone
[Zone No]E ON: Multiple Zone Alarms enabled for that zone

P79E

PROGRAM MODE LEVEL
Installer mode or NessComms.

FACTORY DEFAULT
none

ACCOUNT NO.2 ZONES

Zones selected to be Account No.2 zones will report their Alarms, Restorals and Excludes on Client code 2.

PROGRAMMING SEQUENCE:

P79E [Zone No]E toggles the option ON and OFF

P75E, P92E

REPORT MISCELLANEOUS ALARMS

PROGRAM MODE LEVEL

Installer mode or NessComms.

FACTORY DEFAULT

see table

RELATED OPTIONS

P86E 4E

NOTES

- 0E will turn all selections OFF
- MEMORY E will turn all selections ON

P77E, P93E

REPORT MISCELLANEOUS RESTORALS

PROGRAM MODE LEVEL

Installer mode or NessComms.

FACTORY DEFAULT

see table

	ALARM DEFAULT	RESTORAL DEFAULT	D8		D16	
			ALARM	RESTORAL	ALARM	RESTORAL
Duress		ON	P75E 1E	P77E 1E	P75E 1E	P77E 1E
Medical		ON	P75E 2E	P77E 2E	P75E 2E	P77E 2E
KP Panic & KS Panic	ON	ON	P75E 3E	P77E 3E	P75E 3E	P77E 3E
Fire		ON	P75E 4E	P77E 4E	P75E 4E	P77E 4E
Panel tamper	ON	ON	P75E 5E	P77E 5E	P75E 5E	P77E 5E
External tamper	ON	ON	P75E 6E	P77E 6E	P75E 6E	P77E 6E
Keypad Tamper	ON	ON	P75E 7E	P77E 7E	P75E 7E	P77E 7E
Exit Installer Mode		ON	P75E 8E	P77E 8E	P75E 8E	P77E 8E
Radio Tamper	ON	ON	P92E 1E	P93E 1E	P75E 9E	P77E 9E
Radio Panic	ON	ON	P92E 2E	P93E 2E	P75E 10E	P77E 10E
Radio Battery		ON	P92E 3E	P93E 3E	P75E 11E	P77E 11E
Supervision fail		ON	P92E 4E	P93E 4E	P75E 12E	P77E 12E
Panel battery	ON	ON	P92E 5E	P93E 5E	P75E 13E	P77E 13E
Mains fail	ON	ON	P92E 6E	P93E 6E	P75E 14E	P77E 14E
[not used]		ON	P92E 7E	P93E 7E	P75E 15E	P77E 15E
[not used]		ON	P92E 8E	P93E 8E	P75E 16E	P77E 16E

REPORT MISCELLANEOUS ALARMS

REPORT MISCELLANEOUS RESTORALS

These options select which Miscellaneous alarms will trigger the dialler to send Alarm reports and Restoral reports to the Central Station.

Alarms (if enabled) are sent on activation. Restorals (if enabled) are sent on Opening. Mains Fail and Low Battery Restorals are sent when the power has been restored.

Note the different program option numbers for the D8 and D16.

PROGRAMMING SEQUENCE:

PxxE

1E-8E or 1E-16E toggles the option ON and OFF

Note that several P75E, P92E, P77E, P93E options are automatically turned off when P86E 4E Audible Voice Format (AVF) is enabled. The affected options do not revert to default when AVF is disabled and must be manually reprogrammed if required. See P86E 4E, page 44.

Option No.	Description	Default
P82E	1E Send RESTORAL report immediately	OFF
	2E Send RESTORAL after siren time	OFF
	3E Send RESTORAL after Disarm & seal	OFF
	4E Send RESTORAL after Disarm always	ON

P82E 1E-4E

PROGRAM MODE LEVEL

Installer mode or NessComms.

FACTORY DEFAULT

4E, ON: Always send Restoral on Disarm.

RELATED OPTIONS

P76E Report zone restorals.

RESTORAL REPORTING OPTIONS

This option selects when the dialler sends zone Restoral reports. Only one of the following options may be selected.

Restoral reporting options also apply to 24hr zones.

PROGRAMMING SEQUENCE:

P82E 1E-4E toggles the option ON and OFF

- 1E ON: Send Restoral immediately
- 2E ON: Send Restoral after siren time
- 3E ON: Send Restoral on Disarm & seal
- 4E ON: Send Restoral on Disarm always

PROGRAMMING

Option No.	Description	Default	Note
P83E	TEST CALL INTERVAL	84	x2 = 168hrs
P84E	TIME BEFORE NEXT TEST CALL	6	x2 = 12hrs

P83E

PROGRAM MODE LEVEL

Installer mode or NessComms.

FACTORY DEFAULT

84 (=168hrs =7 days).

NOTES

- Enter a value from 1 to 99.

RELATED OPTIONS

P89E 1E Enable Test Calls.

P84E Time Before Next Test Call.

TEST CALL INTERVAL

Test calls to the Central Station can be sent at intervals between 2 and 198 hours in 2 hour increments.

Programmable from 2 to 198 Hours. Enter a value between 1 and 99. (This is automatically multiplied by 2).

Test Calls must be enabled by option P89E 1E.

PROGRAMMING SEQUENCE:

Press P83E (The existing Test Call Interval time will be displayed.)

Press [NEW TIME] E (The new Test Call Interval time will be displayed.)

EXAMPLE: To program daily test calls.

Press P83E12E

P84E

PROGRAM MODE LEVEL

Installer mode or NessComms.

FACTORY DEFAULT

6 (=12hrs).

NOTES

1. Enter a value from 1 to 99.
2. If Test Calls are to start immediately, then the value is set to 0.
3. The Time Before Next Test Call is constantly updated. When viewed, the current value will be displayed (not the initially entered value).

RELATED OPTIONS

P89E 1E, Enable Test Calls.

P83E, Test Call interval.

TIME BEFORE NEXT TEST CALL

This option sets the time before the next test call and is used to set the preferred time for Test Calls. Programmable from 2 to 198 Hours. Enter a value between 1 and 99. (This is automatically multiplied by 2).

EXAMPLES:

A/ New Installation: Set the time before the next test call.

E.g., If you are programming the panel at 5pm and you want test calls to be sent at 1am. Enter P84E 4E (4 x 2 =8hrs. Therefore 5pm + 8hrs =1am).

B/ Existing Installation: To reset the time that test calls are sent.

E.g., Our example panel is sending test calls at 1am and you want to change it to 2am. If you are programming the panel at 6pm, enter P84E 4E (4 x 2 =8hrs. Therefore 6pm + 8hrs =2am).

PROGRAMMING SEQUENCE:

Press P84E (The existing Time Before Next test call will be displayed. See note 3)

Press [NEW TIME] E (The new Time Before Next test call will be displayed)

INSTALLER'S TIP

Use P88888888E prior to powering down for a short time. This will save the current Time Before Next Test Call and the Real Time Clock into permanent memory. On power up these times will be restored.

PROGRAMMING

Option No.	Description	Default	
P86E	1E	Disable Dialler	OFF
	2E	CONTACT ID FORMAT	ON
	3E	[not used]	OFF
	4E	Audible VOICE Format	OFF
	5E	[not used]	OFF
	6E	Contact ID + VOICE Format	OFF

P86E 1E

PROGRAM MODE LEVEL

Installer mode or NessComms.

FACTORY DEFAULT

Off: dialler enabled.

NOTES

This option is useful for temporary disabling of the dialler without affecting other dialler options.

DISABLE DIALLER

This option disables the dialler even if telephone numbers and other dialler options are programmed.

Up/download or remote telephone access remain enabled.

PROGRAMMING SEQUENCE:

P86E 1E turns the option ON

ON: Dialler disabled

P86E 2E

PROGRAM MODE LEVEL

Installer mode or NessComms.

FACTORY DEFAULT

ON: Contact ID format enabled.

CONTACT ID FORMAT

This option enables the reporting of alarms to a Central S tation via telephone numbers 1 & 2 using Contact ID format.

PROGRAMMING SEQUENCE:

P86E 2E turns the option ON

ON: Contact ID format enabled

The panel reports alarms to the Central Station using Contact ID dialler format.

The message format is fixed as shown in the Contact ID Codes Table.

The message takes the form of:

SSSS	Account Number
Q	Event qualifier 1 = New Event or Open 3 = Restore or Close
XYZ	Alarm type
GG	Group or Area designation
CCC	Alarm number dd = User ID (1 to 56) zz = Zone ID (1 to 16) aa = 01 Area 1 aa = 02 Area 2 aa = 01 Monitor area aa = 00 24 Hr Area K = Checksum (0 to 0f hex)

CONTACT ID REPORTS TABLE

REPORT NAME	SSSS	Q	XYZ	GG	CCC	SUFFIX
Zone 1– Zone 16 Alarm	ssss 18	q	130	aa	001–016	k
Duress	ssss 18	1	121	01	030	k
Keyswitch Panic	ssss 18	1	120	01	031	k
Keypad Panic	ssss 18	1	120	01	032	k
Radio Key Panic	ssss 18	1	120	01	1dd	k
Medical Alarm	ssss 18	1	100	01	033	k
Fire	ssss 18	1	110	01	034	k
Exit Install mode	ssss 18	1	306	01	035	k
External Tamper	ssss 18	q	137	01	040	k
Internal Tamper	ssss 18	q	137	01	041	k
Keypad Tamper	ssss 18	q	137	01	042	k
Radio Sensor Supervision	ssss 18	q	381	01	4zz	k
Radio Sensor Tamper	ssss 18	q	383	01	2zz	k
Radio Sensor Low Battery	ssss 18	q	384	01	3zz	k
Mains Fail	ssss 18	q	301	01	050	k
Panel Battery Fail	ssss 18	q	309	01	051	k
Open (Disarm)	ssss 18	1	402	aa	0dd	k
Force Open (Cancel)	ssss 18	1	406	aa	0dd	k
Close (Arm)	ssss 18	3	402	aa	0dd	k
Closing Extended	ssss 18	3	464	aa	0dd	k
Test Report	ssss 18	1	602	01	063	k
Zone 1-16 Manual Exclude	ssss 18	q	573	aa	001-016	k
Zone 1-16 Auto Exclude	ssss 18	q	380	aa	001-016	k

SPECIAL ARMING/DISARMING REPORTS BY USER

REPORT NAME	User ID	REPORT NAME	User ID
Arm/Disarm by Keyswitch	57	Arm/Disarm by AutoTimer 4	94
Shortcut Arm	58	Arm/Disarm by AutoTimer 5	95
Arm/Disarm by AutoTimer 1	91	Arm/Disarm by AutoTimer 6	96
Arm/Disarm by AutoTimer 2	92	Arm/Disarm by AutoTimer 7	97
Arm/Disarm by AutoTimer 3	93	Arm/Disarm by AutoTimer 8	98

PROGRAMMING

P86E 4E

PROGRAM MODE LEVEL

Installer mode or NessComms.

FACTORY DEFAULT

OFF.

NOTES

See page 83 for operational details.

RELATED OPTIONS

P75E/P92E Misc Reports

P77E/P93E Report Misc Restorals

P76E Report Zone Restorals

P87E 1E, 2E, 4E

P88E Various Dialler Options

P89E 1E, 2E, 4E

AUDIBLE VOICE FORMAT

For Audible Monitoring to any telephone or mobile phone. Zone alarms are sent in Audible VOICE format.

The message is repeated for 45 seconds or until kissed-off by the receiving telephone.

PROGRAMMING SEQUENCE:

P86E 4E turns the option ON

ON: Audible VOICE format enabled

NOTES – RELATED OPTIONS

For your convenience and effective operation of Audible reporting – the control panel automatically sets the following options as shown when Audible Voice Format is enabled.

Note that any of these options can be reprogrammed by the installer to suit the installation. Also, please be aware that in the event that the panel is required to revert from Audible Voice Format to Central Station Monitoring (P86E 2E Contact ID format) you will need to reprogram several of the below options accordingly (ie, manually reprogram these options to their factory default settings which is the best choice for Central Station Monitoring.)

P75E/P92E Misc Reports: All OFF

P77E/P93E Report Misc Restorals: All OFF

This means that Miscellaneous Alarms and Restorals will not trigger the dialler.

(See page 41 for a full list of Miscellaneous alarms)

P76E Report Zone Restorals: All OFF

This means that Zone Restorals will not trigger the dialler. (Zone Alarms are selected ON by default, see P74E, page 40)

P87E options 1E Split Dial, 2E Check for Dial Tone, 4E 4 Dial Attempts will be ON.

(see P87E, page 45)

P88E Various Dialler Options: All OFF

(see P88E, page 46, 47)

P89E 1E Enable test Calls, 2E Mains report Delay will be OFF

P89E 4E Swinger Shutdown will be On

P86E 6E

PROGRAM MODE LEVEL

Installer mode or NessComms.

FACTORY DEFAULT

OFF.

CONTACT ID + AUDIBLE VOICE FORMAT

For simultaneous Central Station and Audible Monitoring.

The alarm message will be sent to the Central Station on the Primary telephone number and then in audible VOICE format to the Follow Me telephone number, (P00E).

PROGRAMMING SEQUENCE:

P86E 6E turns the option ON

ON: Contact ID + Audible VOICE format enabled

Note that some P87E options are automatically enabled when P86E 4E Audible Voice Format (AVF) is enabled.
The affected options do not revert to default when AVF is disabled and must be manually reprogrammed if required.
See P86E 4E, page 44.

Option No.	Description	Default
P87E	1E Split dial Primary/Secondary numbers	OFF
	2E Check for Dial Tone	ON
	3E [not used]	OFF
	4E 4 Dialling attempts	ON
	5E Reduce tone output when dialling telephone number	OFF
	6E Reduce tone output when sending alarm message	OFF
	7E Reduce tone output when connecting to modem	OFF

P87E 1E

PROGRAM MODE LEVEL

Installer mode or NessComms.

FACTORY DEFAULT

OFF: Split Dial.

RELATED OPTIONS

P87E 4E Number of Dialling attempts.

SPLIT DIAL PRIMARY/SECONDARY PHONE NUMBERS

This option selects the order in which Telephone numbers 1 & 2 are dialled.

PROGRAMMING SEQUENCE:

P87E 1E toggles the option ON and OFF

OFF: **Split Dial.** Dial Telephone No.1 for half of the call attempts. If unsuccessful, dial Telephone No.2 for the last half of call attempts.

ON: **Alternate Dial.** Dial Telephone No.1 on the first attempt. If no answer, dial Telephone No.2. Continue alternating until successful.

P87E 2E

PROGRAM MODE LEVEL

Installer mode or NessComms.

FACTORY DEFAULT

ON: Dial only with dial tone.

CHECK FOR DIAL TONE

The dialler can be programmed to check for a dial tone before dialling. The dialler will still dial out if a dial tone is not detected , but this means several seconds will have elapsed. Allows use on PABXs with non-standard dial tones.

PROGRAMMING SEQUENCE:

P87E 2E toggles the option ON and OFF

OFF: Dial without dial tone

ON: Dial only with dial tone

P87E 4E

PROGRAM MODE LEVEL

Installer mode or NessComms.

FACTORY DEFAULT

ON: 4 dialling attempts.

NOTES

- Sets the total number of dialling attempts. E.g. If 4 dialling attempts is selected, this means 2 attempts per telephone number.

RELATED OPTIONS

P87E 1E Alternate dialling.

NUMBER OF DIALLING ATTEMPTS

Sets the number of dialling attempts when sending reports.

OFF: sets a maximum 10 dial attempts before a 5 minute sleep and 10 more re-tries if unsuccessful.

ON: allows a maximum of 4 dial attempts before a 5 minute sleep and 4 more retries if unsuccessful.

If all attempts fail the dialler waits for the next trigger event. The previously unsuccessful report will be included in the new message.

When sending Test Calls, the time between dialling attempts increases to 60 minutes for the second round of dialling. If a Test Call is unsuccessful after the first round of calls are made, another call is made after 5 minutes. If this call fails then subsequent calls are made every hour (up to the maximum number of calls).

PROGRAMMING SEQUENCE:

P87E 4E toggles the option ON and OFF

OFF: Maximum 10 dialling attempts

ON: Maximum 4 dialling attempts

P87E 5E, 6E, 7E

Available in D8x/D16x V8 and later.

PROGRAM MODE LEVEL

Installer mode or NessComms.

FACTORY DEFAULT

OFF

PSTN - REDUCE TONE LEVELS

This option allows PSTN tone levels to be reduced which may be required when the panel is using VOIP type phone lines.

PROGRAMMING SEQUENCE:

P87E 5E, 6E or 7E toggles the option ON and OFF

5E: Reduce tone output when dialling telephone number

6E: Reduce tone output when sending alarm message

7E: Reduce tone output when connecting to modem

PROGRAMMING

Note that some P88E options are automatically turned off when P86E 4E Audible Voice Format (AVF) is enabled.
 The affected options do not revert to default when AVF is disabled and must be manually reprogrammed if required.
 See P86E 4E, page 44.

Option No.	Description	Default	
P88E	1E	Send AREA 1 OPEN/CLOSE REPORTS	OFF
	2E	Send AREA 2 Open/Close reports	OFF
	3E	Siren Chirp on Kiss-off	OFF
	4E	Flash Strobe on Kiss-off	OFF
	5E	Forced Opening report	ON
	6E	Delayed Closing Reports	OFF
	7E	Manual Exclude Reports	ON
	8E	Auto Exclude Reports	ON

P88E 1E

PROGRAM MODE LEVEL
 Installer mode or NessComms.
FACTORY DEFAULT
 OFF: No AREA1 Open/Close reports.

AREA1 OPEN/CLOSE REPORTS

Enables or disables sending of AREA1 Open/Close reports.
 The User ID of the code used is included in the report.
 Keyswitch arming is identified as User 57. Shortcut arming is identified as User 58.

PROGRAMMING SEQUENCE:
P88E 1E toggles the option ON and OFF
 OFF: No AREA1 Open/Close reports
 ON: AREA1 Open/Close reports enabled

P88E 2E

PROGRAM MODE LEVEL
 Installer mode or NessComms.
FACTORY DEFAULT
 OFF: No AREA2 Open/Close.

AREA2 OPEN/CLOSE REPORTS

Enables or disables sending of AREA2 Open/Close reports.

PROGRAMMING SEQUENCE:
P88E 2E toggles the option ON and OFF
 OFF: No AREA2 Open/Close reports
 ON: AREA2 Open/Close reports enabled

P88E 3E

PROGRAM MODE LEVEL
 Installer mode or NessComms.
FACTORY DEFAULT
 OFF: No Siren Chirp on kiss-off.
RELATED OPTIONS
 P88E 4E Flash Strobe on kiss-off.

SIREN CHIRP ON KISS-OFF

Selects a 2 Second Siren burst on a successful Closing report. This is used to give audible indication that the dialler has successfully sent the Arming report.

PROGRAMMING SEQUENCE:
P88E 3E toggles the option ON and OFF
 OFF: No Siren Chirp on kiss-off
 ON: Siren Chirp on kiss-off enabled

P88E 4E

PROGRAM MODE LEVEL
 Installer mode or NessComms.
FACTORY DEFAULT
 OFF: No Strobe Flash on kiss-off.
RELATED OPTIONS
 P88E 3E Siren Chirp on kiss-off.

STROBE FLASH ON KISS-OFF

Selects a 2 Second Strobe on a successful Closing report. This is used to give visual indication that the dialler has successfully sent the Arming report.

PROGRAMMING SEQUENCE:
P88E 4E toggles the option ON and OFF
 OFF: No Strobe Flash on kiss-off
 ON: Strobe Flash on kiss-off enabled

P88E 5E

PROGRAM MODE LEVEL

Installer mode or NessComms.

FACTORY DEFAULT

ON: Forced opening Reports enabled

NOTES

- This option is used to indicate to the Central Station that an alarm has been reset by a valid user.

Usually used in cases where Open/Close reports are normally selected OFF.

FORCED OPENING REPORT

If Forced Opening Report is selected ON – when an alarm has been reset by a valid User Code (or Radio Key), the dialler will send an Opening report along with a restoral report for the zone or miscellaneous input which caused the alarm.

PROGRAMMING SEQUENCE:

P88E 5E toggles the option ON and OFF

OFF: No Forced opening Reports

ON: Forced opening Reports enabled

P88E 6E

PROGRAM MODE LEVEL

Installer mode or NessComms.

FACTORY DEFAULT

OFF: Closing Reports sent on Arming.

RELATED OPTIONS

P88E 1E AREA1 Open/Close reports.

P88E 2E AREA2 Open/Close reports.

DELAY CLOSING REPORT

If selected ON, Closing reports (if enabled) are sent at the end of Exit Time. Normally, Closing reports are sent immediately on arming.

PROGRAMMING SEQUENCE:

P88E 6E toggles the option ON and OFF

OFF: Closing Reports sent on Arming

ON: Closing Reports sent at end of Exit Time

P88E 7E

PROGRAM MODE LEVEL

Installer mode or NessComms.

FACTORY DEFAULT

ON: Manual Exclude Reports enabled.

RELATED OPTIONS

P88E 8E Auto Exclude Reports.

MANUAL EXCLUDE REPORT

Enables Manual Exclude Reports for zones. Exclude Reports for 24hr zones are sent on exiting EXCLUDE mode.

PROGRAMMING SEQUENCE:

P88E 7E toggles the option ON and OFF

OFF: No Manual Exclude Reports

ON: Manual Exclude Reports enabled

P88E 8E

PROGRAM MODE LEVEL

Installer mode or NessComms.

FACTORY DEFAULT

ON: Auto Exclude Reports enabled.

RELATED OPTIONS

P88E 7E Manual Exclude Reports.

AUTO EXCLUDE REPORT

Enables Auto Exclude Reports for Zones. Zones not sealed on arming will be reported as Auto Excluded..

PROGRAMMING SEQUENCE:

P88E 8E toggles the option ON and OFF

OFF: No Auto Exclude Reports

ON: Auto Exclude Reports enabled

PROGRAMMING

Note that some P89E options are automatically turned off when P86E 4E Audible Voice Format (AVF) is enabled.
The affected options do not revert to default when AVF is disabled and must be manually reprogrammed if required.
See P86E 4E, page 44.

Option No.	Description	Default	
P89E	1E	ENABLE TEST CALLS	ON
	2E	Mains Report Delay (1 hour)	ON
	3E	Listen-In to Dialler	OFF
	4E	Swinger shutdown	ON
	5E	Line Fault Monitor	OFF
	6E	[not used]	OFF
	7E	[not used]	OFF
	8E	[not used]	OFF

P89E 1E

PROGRAM MODE LEVEL

Installer mode or NessComms.

FACTORY DEFAULT

ON: Test Calls enabled.

RELATED OPTIONS

P83E Test Call Interval.

P84E Time before next Test call.

P87E 4E Number Of Dialling Attempts.

ENABLE TEST CALLS

This option enables the reporting of dialler test calls to the Central station.

PROGRAMMING SEQUENCE:

P89E 1E toggles the option ON and OFF

OFF: No Test Calls

ON: Test Calls enabled

P89E 2E

PROGRAM MODE LEVEL

Installer mode or NessComms.

FACTORY DEFAULT

ON: Mains Fail report is delayed.

MAINS REPORT DELAY

This option allows Mains Fail reports to be delayed by one hour if the mains power has been off continuously for that time. This avoids mains fail reports being sent to the Central Station in the event of brief power failures.

PROGRAMMING SEQUENCE:

P89E 2E toggles the option ON and OFF

OFF: Mains Fail reports immediately

ON: Mains Fail report is delayed by 1 hour

P89E 3E

PROGRAM MODE LEVEL

Installer mode or NessComms.

FACTORY DEFAULT

OFF: No Listen-In.

NOTES

Use METHOD 1 if you already have the panel box open and have a spare horn speaker on hand.

Use METHOD 2 if the box is closed and you need to quickly listen in to the dialler. Keep in mind that the dialler tones will be heard via any horn speaker/s connected to the Siren output.

LISTEN-IN TO DIALLER

This is a diagnostic feature to allow the installer to hear the dialler message and other telephone tones through a horn speaker.

There are 2 methods of listening to the dialler.

METHOD 1: Temporarily connect a horn speaker to the LISTEN pins on the main board. This method required no programming options to be set - the LISTEN pins are always active.

METHOD 2: This method requires option P89E 3E to be turned on. Listen-In is enabled for a minimum of 4 minutes after exiting Program Mode.

During Method 2 Listen-In, the dialler message and other telephone tones can be heard through the Siren output (at low volume) while the dialler is sending reports. The 4 minute period is restarted whenever any key on the keypad is pressed.

To turn Listen-In off, go back into Installer Program mode and toggle the option OFF.

PROGRAMMING SEQUENCE:

P89E 3E toggles the option ON and OFF

OFF: Method 2 Listen-In disabled

ON: Method 2 Listen-In enabled

P89E 4E

PROGRAM MODE LEVEL

Installer mode or NessComms.

FACTORY DEFAULT

ON: Swinger Shutdown enabled.

NOTES

This prevents unnecessary multiple alarms reported to the Central station in cases, for example, where a door is 'swinging' in the wind.

This option only applies to zones enabled to Report Multiple Zone Alarms.

RELATED OPTIONS

P78E Report Multiple Zone Alarms.

SWINGER SHUTDOWN

Limits the number of calls made by a zone alarm in any one armed period.

Alarm reports are normally limited to 15 multiple reports per zone.

When Swinger Shutdown is enabled, multiple reports are reduced to 3 multiple reports per zone.

PROGRAMMING SEQUENCE:

P89E 4E toggles the option ON and OFF

OFF: Swinger Shutdown is 15 reports per zone

ON: Swinger Shutdown is 3 reports per zone

P89E 5E

PROGRAM MODE LEVEL

Installer mode or NessComms.

FACTORY DEFAULT

OFF: No Line Fault Monitor.

RELATED OPTIONS

P122E 5E Line Fault to AUX2.

LINE FAULT MONITOR

When this option is enabled, the telephone line is regularly tested. If the telephone line is not found, the CELL (or LINE) icon will commence flashing.

PROGRAMMING SEQUENCE:

P89E 5E toggles the option ON and OFF

OFF: No Line Fault Monitor

ON: Line Fault Monitor enabled

PROGRAMMING

Option No.	Description	Default	
P90E	1E	Enable Remote Access	OFF
	2E	Enable First Call Mode	OFF
	3E	Enable Remote Arming	OFF
	4E	Enable Remote Disarming	OFF
	5E	Enable Remote AUX control	OFF
	6E	Enable Remote Status reporting	OFF
	7E	Enable Remote Event Report	OFF
	8E	Enable Callback Mode	OFF

P90E 1E

PROGRAM MODE LEVEL

Installer mode or NessComms.

FACTORY DEFAULT

OFF: No Remote Access.

RELATED OPTIONS

P91E Required Rings.

REMOTE ACCESS

When selected on, this option allows the panel to be remotely upload/downloaded by a remote computer or controlled by a remote telephone.

When the option is Off, the panel will not answer incoming telephone calls, preventing any type of remote access while the panel is in normal Operating Mode.

WHEN THE PANEL IS IN INSTALLER PROGRAM MODE IT WILL ANSWER ALL INCOMING CALLS regardless of the P90E 1E setting.

PROGRAMMING SEQUENCE:

P90E 1E toggles the option ON and OFF

OFF: No Remote Access

ON: Remote Access enabled

P90E 2E

PROGRAM MODE LEVEL

Installer mode or NessComms.

FACTORY DEFAULT

OFF: Second Call Mode enabled.

NOTES

If Callback is enabled (P90E 8E is on), then First Call mode is disabled.

RELATED OPTIONS

P91E Required Rings.

ENABLE "FIRST CALL" MODE

For remote access the panel can answer incoming telephone calls on either the First or Second Call.

First Call Mode: The panel answers a telephone call after the number of rings set by P91E. Used if the panel has exclusive use of the the telephone line.

Second Call Mode: The panel answers on the second telephone call. The first telephone call must ring for at least the number of rings set by P91E. The second call to the panel must be made after a wait of between 10 and 50 seconds. Second Call mode is used to stop other equipment such as fax machines from answering the call.

PROGRAMMING SEQUENCE:

P90E 2E toggles the option ON and OFF

OFF: Second Call Mode enabled

ON: First Call Mode enabled

P90E 3E

PROGRAM MODE LEVEL

Installer mode or NessComms.

FACTORY DEFAULT

OFF: No Remote Arming.

NOTES

- Remote Access must also be enabled.

RELATED OPTIONS

P90E 1E Enable Upload/Download.
See page 85 for details on Remote Operation by telephone.

REMOTE ARMING

Allows the control panel to be armed remotely by telephone, using a standard DTMF telephone or mobile phone.

PROGRAMMING SEQUENCE:

P90E 3E toggles the option ON and OFF

OFF: No Remote Arming

ON: Remote Arming enabled

P90E 4E

PROGRAM MODE LEVEL

Installer mode or NessComms.

FACTORY DEFAULT

OFF: No Remote Disarming.

P90E 5E

PROGRAM MODE LEVEL

Installer mode or NessComms.

FACTORY DEFAULT

OFF: No Remote AUX control.

NOTES

This option must be on to globally enable remote control of the AUX outputs. See the options for AUX1-4 to individually enable each AUX output for remote control.

RELATED OPTIONS

P141E 5E Telephone control AUX1
 P142E 5E Telephone control AUX2
 P143E 5E Telephone control AUX3
 P144E 5E Telephone control AUX4

P90E 6E

Available in D8x/D16x V5.6 and later.

PROGRAM MODE LEVEL

Installer mode or NessComms.

FACTORY DEFAULT

OFF: No Remote Status Reporting.

P90E 7E

PROGRAM MODE LEVEL

Installer mode or NessComms.

FACTORY DEFAULT

OFF: No Remote Event Reporting.

NOTES

When this option is off, the NessComms *Receive Events* function will appear to download the event history from the panel, however the NessComms event display will (correctly) be blank.

P90E 8E

PROGRAM MODE LEVEL

Installer mode or NessComms.

FACTORY DEFAULT

OFF: No Callback.

RELATED OPTIONS

P90E 1E Enable Upload/Download.
 P81E Telephone Number 4, Callback.

REMOTE DISARMING

Allows the control panel to be disarmed remotely by telephone, using a standard DTMF telephone or mobile phone.

PROGRAMMING SEQUENCE:

P90E 4E toggles the option ON and OFF

OFF: No Remote Disarming

ON: Remote Disarming enabled

REMOTE AUX CONTROL

Enables the remote turn ON/OFF of the AUX1, 2, 3 and 4 outputs using a standard DTMF telephone or mobile phone.

PROGRAMMING SEQUENCE:

P90E 5E toggles the option ON and OFF

OFF: No Remote AUX control

ON: Remote AUX control enabled

REMOTE STATUS AND ARMING

Enables Remote Status Reporting and Arming using NESSCOMMS™ software.

This option allows Remote Viewing of the current arming and alarm states and Remote Keypad Operation including arming & disarming.

Requires NessComms™ V5.2 and later.

PROGRAMMING SEQUENCE:

P90E 6E toggles the option ON and OFF

OFF: No Remote Status Reporting

ON: Remote Status Reporting enabled

REMOTE EVENT REPORTING

Enables Remote Event Reporting

PROGRAMMING SEQUENCE:

P90E 7E toggles the option ON and OFF

OFF: No Remote Status Reporting

ON: Remote Status Reporting enabled

CALLBACK MODE

Enables two methods of connecting by computer for remote upload/download.

NO CALLBACK – Allows remote access by computer as long as the panel's Account Number (P72E) is known. The panel answers on the 2nd incoming call.

WITH CALLBACK – The panel will answer the 2nd call, verify the caller, hang up and then make the Callback using Telephone Number 4.

PROGRAMMING SEQUENCE:

P90E 8E toggles the option ON and OFF

OFF: No Callback

ON: Callback Mode enabled

PROGRAMMING

Option No.	Description	Default	Note
P91E	REQUIRED RINGS TO ANSWER	1	1 to 24 rings

P91E

PROGRAM MODE LEVEL
Installer mode or NessComms.

FACTORY DEFAULT

1

NOTES

- 'Double Ring' signals count as one ring. (Double rings are less than 1sec apart).
- The panel counts all types of ring signals as Rings, including Distinctive Rings.

RELATED OPTIONS

P90E 1E to 8E (Remote Access options).

REQUIRED RINGS

Sets the number of rings before an incoming call is answered. This is used for remote access of the panel either by NessComms software or user operation by telephone.

Remote Access can work in First Call or Second Call modes, see option P90E 2E.

Programmable from 1 to 24 rings. Enter a value between 1 and 24.

INSTALLER'S TIP. Rings are counted in the panel as a ring signal followed by a period of silence. For instance, on the first ring the count is not registered until the second ring starts.

PROGRAMMING SEQUENCE:

P91E existing Required Rings value is displayed one digit at a time

[ENTER NEW VALUE] E new Required Rings value is displayed one digit at a time

Option No.	Description	ZONES 1-8 (D8 & D16)							
		1	2	3	4	5	6	7	8
P94E	"NO MEMORY WARNING"ZONES								

P94E

PROGRAM MODE LEVEL
Installer mode or NessComms.

FACTORY DEFAULT

no zones selected.

NOTES

Applies to zones 1-8 only (D8x and D16x)

NO MEMORY WARNING ZONES

Select zones that do not flash the Memory indicator on the keypad/s. Alarm events on those zones are still stored in memory and can be reviewed as normal.

PROGRAMMING SEQUENCE:

P94E 1E-16E toggles the option ON and OFF

[Zone No]E OFF: Memory Warning operates normally for that zone

[Zone No]E ON: Memory Warning is disabled for that zone

These options allow selective restoring of various factory defaults. For example, you can default (clear) all the User Codes, without affecting any other programmed options.

Option No. Description

Option No.	Description
P95E	CLEAR RADIO DEVICES
P96E	CLEAR MEMORY
P97E	CLEAR PANEL OPTIONS (RESTORE FACTORY DEFAULTS)
P98E	CLEAR USER CODES
P99E	PROGRAM INSTALLER CODE

P95E

PROGRAM MODE LEVEL

Installer mode or NessComms.

FACTORY DEFAULT

[not applicable]

CLEAR RADIO DEVICES

This option clears all Radio Devices assigned to zones 1–8 or 1–16.

(This option does not clear User Codes).

PROGRAMMING SEQUENCE:

P95E Clears Radio Device Codes

P96E

PROGRAM MODE LEVEL

Installer mode or NessComms.

FACTORY DEFAULT

[not applicable]

CLEAR MEMORY

Enter P96E when in Installer Program mode to clear all events in the Alarm memory display.

Note: This option clears only the 20 event memory as read by KPX and LCD keypads. Ness Navigator touch screen keypad's 80 event memory is not affected.

PROGRAMMING SEQUENCE:

P96E Clears Alarm Memory display

P97E

PROGRAM MODE LEVEL

Installer mode or NessComms.

FACTORY DEFAULT

[not applicable]

NOTES

Note, this option will also delete Radio Devices programmed on zones.

CLEAR PANEL OPTIONS

This option restores 'panel' program options to their factory default values. Defaults all program options except User Codes and Radio Codes.

Note, this option will also delete Radio Devices programmed on zones.

PROGRAMMING SEQUENCE:

P97E Restores Factory Defaults

P98E

PROGRAM MODE LEVEL

Installer mode or NessComms.

FACTORY DEFAULT

User Code 1: 123

All other codes: [blank]

NOTES

- This option DOES NOT clear the Installer Code.

CLEAR USER CODES

This option clears all User Codes, (this means all Keypad Codes, Radio Keys and Access cards) and restores User Code 1 to the factory setting of 123.

P201E – P256E are defaulted (User Codes 1–56)

PROGRAMMING SEQUENCE:

P98E Clears User Codes

P99E

PROGRAM MODE LEVEL

Installer mode or NessComms.

FACTORY DEFAULT

000000

PROGRAM THE INSTALLER CODE

Programs the installer code. This code can be 3 to 6 digits long. Factory default installer code is 000000.

PROGRAMMING SEQUENCE:

P99E [Enter new code]E [Enter new code again]E

(Unlike User Codes, the installer code is not displayed when programming)

For a complete list of factory default values, see the Programming Options Summary on pages 86–91.

PROGRAMMING

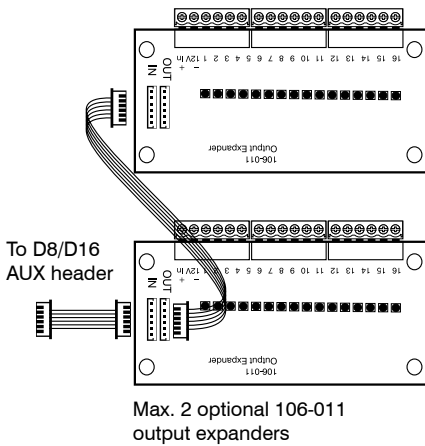

Option No.	Description	Default	
P117E	1E	Enable Output Expander	OFF
	2E	Expander Output Format A & B	OFF
	3E	Day Zone follower	OFF
	4E	Output Exclude	OFF
	5E	Expander Output Format C	OFF
	6E	User Code Toggle or Pulse	OFF
	7E	[not used]	OFF
	8E	[not used]	OFF

P117E 1E

PROGRAM MODE LEVEL

Installer mode or NessComms.

FACTORY DEFAULT

OFF: No Output Expander.

NOTES

- Connect up to two Output Expander boards.

ENABLE OUTPUT EXPANDER

Selecting this option enables the optional 106-011 Output Expander/s (two expanders can be connected as per the diagram on this page).

When this option is enabled, the AUX connector on the main board will only drive the Output Expander.

When this option is disabled, the AUX header is used for the 106-013 Four Relay Board.

PROGRAMMING SEQUENCE:

P117E 1E toggles the option ON and OFF

OFF: No Output Expander

ON: Output Expander enabled

P117E 2E

PROGRAM MODE LEVEL

Installer mode or NessComms.

FACTORY DEFAULT

OFF

NOTES

- The second expander plugs into the second 6-way header on the first expander. The expander closest to the panel becomes Expander 1.
- The User Code outputs will follow the ON/OFF state of the User Codes 13 to 15. These outputs can be made to change via:

A) Radio key. Pressing the ON button turns the output On, OFF turns it OFF. A Radio key must be programmed to a User Code 13~15 for this will operate.

B) Radio keypad auxiliary key. The radio keypad auxiliary key (there are 2 auxiliary keys) must be programmed to a User Code 13~15.

C) The D8x/D16x keypad using ARM - DISARM with a User Code. Enter Arm+User_Code_13~15 to turn the output on. User_Code_13~15 + E will turn the output off.

Note that the USER CODE does not have to be assigned to an AREA for this to work.

- If P117E 6E is ON then the ARM, DISARM buttons on Radio Keys do not change the Code13-15 outputs on the output expander.

Only the AUX button works, pulsing ON the Code13-15 output for the time set by P145E.

EXPANDER OUTPUT FORMAT A, B, C

Use this option along with option P117E 5E to configure the output expander outputs as per the output tables.

Three different combinations of outputs are available for either a single or dual output expanders.

PROGRAMMING SEQUENCE:

P117E 2E toggles the option ON and OFF

OUTPUT	Output Format A		Output Format B		Output Format C	
	EXPANDER 1 (Or if using only one expander)	EXPANDER 2	EXPANDER 1 (Or if using only one expander)	EXPANDER 2	EXPANDER 1 (Or if using only one expander)	EXPANDER 2
	P117E 1E = ON P117E 2E = OFF P117E 5E = OFF		P117E 1E = ON P117E 2E = ON P117E 5E = OFF		P117E 1E = ON P117E 2E = OFF P117E 5E = ON	
1	Zone 1	Aux 5	Zone 1	Aux 5	Aux 5	Zone 1
2	Zone 2	Aux 6	Zone 2	Aux 6	Aux 6	Zone 2
3	Zone 3	Aux 7	Zone 3	Aux 7	Aux 7	Zone 3
4	Zone 4	Aux 8	Zone 4	Aux 8	Aux 8	Zone 4
5	Zone 5	User Code 13	Zone 5	User Code 13	User Code 13	Zone 5
6	Zone 6	User Code 14	Zone 6	User Code 14	User Code 14	Zone 6
7	Zone 7	User Code 15	Zone 7	User Code 15	User Code 15	Zone 7
8	Zone 8	Tel. Line Fail	Zone 8	Tel. Line Fail	Tel. Line Fail	Zone 8
9	Zone 9	Aux 1	Aux 1	Zone 9	Aux 1	Zone 9
10	Zone 10	Aux 2	Aux 2	Zone 10	Aux 2	Zone 10
11	Zone 11	Aux 3	Aux 3	Zone 11	Aux 3	Zone 11
12	Zone 12	Aux 4	Aux 4	Zone 12	Aux 4	Zone 12
13	Zone 13	Arm Home	Arm Home	Zone 13	Arm Home	Zone 13
14	Zone 14	Mains Fail	Mains Fail	Zone 14	Mains Fail	Zone 14
15	Zone 15	Battery Fail	Battery Fail	Zone 15	Battery Fail	Zone 15
16	Zone 16	Ext. Tamper	Ext. Tamper	Zone 16	Ext. Tamper	Zone 16

P117E 3E

PROGRAM MODE LEVEL

Installer mode or NessComms.

FACTORY DEFAULT

OFF: No Day Zone Follower.

NOTES

- Day zone outputs are turned off when the panel is in Home or Area modes.

P117E 4E

PROGRAM MODE LEVEL

Installer mode or NessComms.

FACTORY DEFAULT

OFF: No Output Exclude.

P117E 5E

Available in D8x/D16x V8 and later.

PROGRAM MODE LEVEL

Installer mode or NessComms.

FACTORY DEFAULT

OFF

NOTES

If P117E 2E is ON, then P117E 5E is ignored

P117E 6E

Available in D8x/D16x V8 and later.

PROGRAM MODE LEVEL

Installer mode or NessComms.

FACTORY DEFAULT

OFF

DAY ZONE FOLLOWER

This option allows Day zones to appear on the Zone Outputs.

In Day mode the Zone Output will follow the state of any active Day zone. This occurs independently of the Program Zone selections P118E (Output Expander Zone Follower) and P119E (Output Expander Zone Latch).

PROGRAMMING SEQUENCE:

P117E 3E toggles the option ON and OFF

OFF: No Day Zone Follower

ON: Day Zone Follower enabled

OUTPUT EXCLUDE

This allows zones selected for Manual Exclusion (not Auto Exclusion) to also Exclude the Expander Zone outputs. With this option ON, and if a zone has been manually excluded then it will not signal an alarm on the Expander.

PROGRAMMING SEQUENCE:

P117E 4E toggles the option ON and OFF

OFF: No Output Exclude

ON: Output Exclude enabled

EXPANDER OUTPUT FORMAT C

Use this option along with option P117E 2E to configure the output expander outputs as per the output tables.

Three different combinations of outputs are available for either a single or dual output expanders.

PROGRAMMING SEQUENCE:

P117E 5E toggles the option ON and OFF

USER CODE TOGGLE OR PULSE

Selecting this option changes the User Code 13 to 15 operations to pulse on Radio Key AUX button.

This allows up to three users to remotely control separate access points such as garage doors.

Note that other actions set for the Radio Key AUX button are unchanged.

PROGRAMMING SEQUENCE:

P117E 6E toggles the option ON and OFF

PROGRAMMING

Option No.	Description	ZONES 1-8 (D8 & D16)								ZONES 9-16 (D16)							
		1	2	3	4	5	6	7	8	9	10	11	12	13	14	15	16
P118E	OUTPUT EXPANDER ZONES																
P119E	OUTPUT EXPANDER ALARM ZONES																

P118E

PROGRAM MODE LEVEL

Installer mode or NessComms.

FACTORY DEFAULT

All OFF: No Output Expander zones.

NOTES

- Selecting a zone in both P118 & P119 options effectively gives pulsed outputs whenever that zone alarms.

OUTPUT EXPANDER ZONES

This selects the zones that will be output whenever the zone is unsealed. When the zone reseals the output automatically goes off.

Additionally if a zone is also selected in P119 (to zone latch) then an output will only occur whenever a zone is in alarm and is also unsealed. In this case when the zone reseals the output automatically goes off again. A further zone unseal will turn the zone Expander output On again.

PROGRAMMING SEQUENCE:

P118E 1E-16E toggles the options ON and OFF

[Zone No]E OFF: Output Expander disabled for that zone

[Zone No]E ON: Output Expander enabled for that zone

P119E

PROGRAM MODE LEVEL

Installer mode or NessComms.

FACTORY DEFAULT

OFF: No Output Expander zone latch.

OUTPUT EXPANDER ALARM ZONES

This selects the zones that will be output whenever the zone is latched into alarm. The output goes off only when the alarm system is reset.

Additionally if a zone is also selected in P118 (to zone follow) then an output will only occur whenever a zone is in alarm and is also unsealed. (See P118 above).

PROGRAMMING SEQUENCE:

P119E 1E-16E toggles the option ON and OFF

[Zone No]E OFF: Output Expander zone alarm disabled for that zone

[Zone No]E ON: Output Expander zone alarm enabled for that zone

PROGRAM MODE LEVEL

Installer mode or NessComms.

Option No.	Description	Default
P120E	1E Latched keyswitch input	OFF
	2E Siren Chirp on Home Arming by Radio	OFF
	3E Radio Key AUX arms Home Monitor	OFF
	4E Keyswitch ARM only	OFF
	5E Keyswitch Disarm only	OFF
	6E Smart Beep	OFF
	7E Entry Delay Timer1 x10	OFF
	8E Area2 Disarm by Keyswitch Allowed	OFF

PROGRAMMING SEQUENCE:

P120E [1E-6E] Turns options on or off.

P120E 1E

RELATED OPTIONS

P60E 2E, 3E Keyswitch options.

LATCHED KEYSWITCH

This option enables the use of a latched, (2 position on/off), keyswitch. Keyswitch operation must first be enabled using options P60E 2E, 3E, page 24.

NOTE: ENABLING LATCHED KEYSWITCH DISABLES ALL OTHER METHODS OF ARMING AND DISARMING (KEYPAD, RADIO KEY, CARD).

OFF: No Latched Keyswitch. (Factory default). ON: Latched Keyswitch enabled.

P120E 2E

NOTE. This option enables Radio Key Home Arming chirps regardless of the state of P64E 4E (Radio Key siren chirps).

RELATED OPTIONS

P64E 6E Strobe Flash on Home Arming by Radio.

SIREN CHIRP ON HOME ARMING BY RADIO

This option enables siren chirps when arming and disarming Home Mode with a Radio Key.

OFF: No Home Arm chirps. (Factory default). ON: Home Arm chirps enabled.

P120E 3E

NOTE

This option enables Radio Key Home Arming chirps regardless of the state of P64E 4E (Radio Key siren chirps).

RELATED OPTIONS

P69E 5E Radio key Home arm by ON/OFF buttons.

P120E 4E

RELATED OPTIONS

P120E 1E Latched Keyswitch.
P60E 2E, 3E Keyswitch options.

P120E 5E

RELATED OPTIONS

P120E 1E Latched Keyswitch.
P60E 2E, 3E Keyswitch options.

P120E 6E

NOTES

- The zone causing the event is saved and can be identified by viewing MEMORY. Only one of the same consecutive zone warnings is saved, although the MEMORY display will flash each time (unless disabled by P94E option).
- Smart Beeps work in addition to any other outputs mapped to Home and Day alarms, as programmed by options P63E 1E-8E.
- Smart Beeps work in conjunction with any other Home and Day mode outputs, (as set by options P63E 1E-8E).

P120E 7E

Available in D8x/D16x V5.6 and later.

RELATED OPTIONS

P26E Entry Delay Time1.

P120E 8E

Available in D8x/D16x V5.6 and later.

RELATED OPTIONS

P60E 2E, 3E. P120E 1E, 4E, 5E.

RADIO AUX BUTTON ARMS HOME MODE

This option enables the AUX button on a Ness RK4 Radio Key to arm Home Mode.

When this option is enabled, options P122E 3E & 4E will be disabled, (AUX button to Aux2 options. See page 60).

(This option is independent of P69E 5E, Home arming by radio key ON/OFF buttons).

OFF: No AUX button Home Arm. (Factory default). ON: AUX button Home Arm enabled.

KEYSWITCH DISARM ONLY

Converts the use of keyswitch operation using P60E 2E and 3E to only DISARM either from Area or Home mode. Keyswitch operation must first be enabled using options P60E 2E, 3E, page 24.

OFF: Keyswitch arms and disarms. (Factory default). ON: Keyswitch disarms only.

KEYSWITCH ARM ONLY

Converts the use of keyswitch operation using P60E 2E and 3E to only ARM either from Area or Home mode.

Keyswitch operation must first be enabled using options P60E 2E, 3E, page 24 .

OFF: Keyswitch arms and disarms. (Factory default). ON: Keyswitch arms only.

SMART BEEPS

Smart Beeps are available in Brief Home or Brief Day mode to identify zones by keypad beeps.

When a Home zone or Day zone is triggered, the zone number is slowly beeped out, followed by 2 seconds of silence. This is repeated 3 times and can be stopped by another beep (such as keypress).

If the zone has entry delay you will hear the Smart Beeps sequence once when the zone is triggered and again at the end of entry delay. If Entry Beeps are disabled (P60E 1E), Smart Beeps will only be heard at the end of entry delay.

Smart Beeps use the keypad/s onboard sonalert, so option P63E 3E and/or 7E must be on to enable the sonalert output for Home alarms and Day alarms.

OFF: Smart Beeps disabled. (Factory default). ON: Smart Beeps enabled.

ENTRY DELAY EXTENDER

Increases the Entry Delay Time1 by a factor of 10. Example, if P26E is programmed for 30 sec, it becomes 300 sec. (Entry Delay Time2 is unaffected).

OFF: Normal Entry Delay Time. (Factory default). ON: Entry Delay Multiplied by 10.

AREA2 DISARM BY KEYSWITCH ALLOWED

This option allows the keyswitch (if enabled) to disarm Area2. Note, the keyswitch cannot arm Area2, only disarm. Though it can can both arm & disarm Area1.

OFF: Option Disabled. (Factory default). ON: Option Enabled.

PROGRAMMING

AUX1 OUTPUT OPTIONS

Only one of the P121E options may be selected.

Option No.	Description	Default
P121E 1E	Zone alarms to AUX1 (P58E selects zones)	ON
2E	Zone Supervision alarms to AUX1	OFF
3E	Radio key Panic TOGGLE	OFF
4E	Radio key Panic PULSE	OFF
5E	[not used]	OFF
6E	[not used]	OFF
7E	Door Open Too Long (DOTL) alarm to AUX1	OFF
8E	Reader [x] output pulses AUX1	OFF

Any or all of the P141E options may be selected.

Option No.	Description	Default
P141E 1E	Area 1 Armed to AUX1	OFF
2E	Area 2 Armed to AUX1	OFF
3E	Home Armed to AUX1	OFF
4E	Keypad toggle AUX1	OFF
5E	Telephone remote control of AUX1	OFF
6E	[not used]	OFF
7E	[not used]	OFF
8E	Pulse AUX1	OFF

P121E 1E – 8E

PROGRAM MODE LEVEL

Installer mode or NessComms.

FACTORY DEFAULT

1E on.

NOTES

Only one option can be on. Turning an option on turns off another.

RELATED OPTIONS

P141E 1E-8E Enhanced AUX1 options.
 P354E 5E-6E AutoTimer1 AUX1 options.
 P359E 5E-6E AutoTimer2 AUX1 options.
 P364E 5E-6E AutoTimer3 AUX1 options.
 P369E 5E-6E AutoTimer4 AUX1 options.

P121E 1E

RELATED OPTIONS

P58E Aux1,3 zones.

P121E 2E

RELATED OPTIONS

P65E, P66E, P67E Radio Supervision.

P121E 3E

Available in D8x/D16x V6 and later.

NOTES

When this option is on, Radio Key Panic buttons will no longer sound alarms or report alarms by dialler.

RELATED OPTIONS

P350E to P369E. AutoTimers 1 to 4.

P121E 4E

NOTES

When this option is on, Radio Key Panic buttons will no longer sound alarms or report alarms by dialler.

RELATED OPTIONS

P145E AUX1 Timer

P121E 7E

RELATED OPTIONS

P303E DOTL zones.
 P304E DOTL timer.

P121E 8E

RELATED OPTIONS

P318E, P328E, P338E, P319E, P329E, P339E.

AUX1 OUTPUT OPTIONS

P121E is one of several options which control the behaviour of the AUX1 output.

One of the most powerful features of the D8x/D16x panels is the flexibility to control the AUX outputs by various events and alarms. If the AUX1 output does not behave as expected, please check all related options such as AutoTimers and P141E options.

TO PROGRAM

1. Press **P121E**.
2. Press **1E ... 8E** to turn an option on. Only one option can be on.

ZONE ALARMS TO AUX1

With this option ON, zones selected in P58E will turn on Aux1 when they go into alarm. The Aux1 output turns off when the panel is disarmed/reset.

ZONE SUPERVISION ALARMS TO AUX1

Setting this option turns the AUX1 output ON when a SUPERVISED RADIO alarm is triggered. The Aux1 output turns off when the panel is disarmed/reset.

ENABLE AUX1 FOR AUTOTIMER / RADIO KEY PANIC TOGGLES AUX1

Dual action programming option.

When this option is on, AUX1 IS ENABLED FOR USE BY AUTOTIMER and RADIO KEY/S PANIC BUTTON WILL TOGGLE THE AUX1 OUTPUT.

RADIO KEY PANIC PULSES AUX1

When this option is on, Radio Key/s Panic button will PULSE the Aux1 output.

DOOR OPEN TOO LONG (DOTL) ALERTS TO AUX1

This option enables DOTL zones (P303E) to turn on Aux1 when the DOTL Time (P304E) expires.

READER OUTPUT TO AUX1

This option enables an access control reader to pulse Aux1 when a valid access card is presented. Set the reader using P318E, P328E or P338E.

AUX1 OUTPUT OPTIONS

P141E 1E – 8E

Available in D8x/D16x V6 and later.

PROGRAM MODE LEVEL

Installer mode or NessComms V5.3 or later.

FACTORY DEFAULT

All off.

NOTES

Any or all options may be selected on.

ENHANCED AUX1 OUTPUT OPTIONS

The P141E enhanced AUX1 options work along with P121E and AutoTimers to provide multiple choices of events and alarms to control AUX1.

TO PROGRAM

1. Press **P141E**.
2. Press **1E ... 8E** to turn an option on. Multiple options can be selected.

P141E 1E

AREA 1 ARMED TO AUX1

Turns on AUX1 while Area 1 is armed.

P141E 2E

AREA 2 ARMED TO AUX1

Turns on AUX1 while Area 2 is armed.

P141E 3E

HOME ARMED TO AUX1

Turns on AUX1 while armed in Home mode.

P141E 4E

KEYPAD TOGGLE AUX1

When this option is on,
 AUX1 is turned ON or PULSED with the keypress 11* (* = Left hand STAR button).
 AUX1 is turned OFF with the keypress 11# (# = Right hand STAR button).

P141E 5E

NOTES

Remote operation by telephone procedure as detailed in the user and installation manuals must be followed before access is allowed. This includes entering a valid user code.

RELATED OPTIONS

P90E 5E, Enable remote Aux control.
 P141E 8E Pulse AUX1.

TELEPHONE REMOTE CONTROL OF AUX1

When this option is on and you have connected to the panel by telephone remote control:
 AUX1 is turned ON or PULSED with the telephone keypress 11*
 AUX1 is turned OFF with the telephone keypress 11#

FEEDBACK TONES HEARD BY PHONE:

- 3 BEEPS: The AUX has been turned ON or is already ON.
- 1 BEEP: The AUX has been turned OFF or is already OFF.
- 1 LONG BEEP: Error. Remote AUX operation by telephone is not enabled.

P141E 8E

RELATED OPTIONS

P145E, AUX1 Pulse Time.

PULSE AUX1

This option converts the P121E 1E and the P141E 1E, 2E, 3E, 4E, 5E options into a pulsed AUX1 output.
 AUX1 is pulsed on for the time set in P145E.

Option No.	Description	Default	Note
P145E	AUX1 TIMER	20 sec	1 to 99 seconds

P145E

Available in D8x/D16x V6 and later.

PROGRAM MODE LEVEL

Installer mode or NessComms V5.3 or later.

FACTORY DEFAULT

20 sec.

RELATED OPTIONS

P141E 8E

AUX1 TIMER

Sets the length of pulse time for the AUX1 output when the P141E 8E option is selected. Select 1 to 99 seconds.

TO PROGRAM

- Press P145E (The existing Pulse Time will be displayed).
- Press [NEW TIME] E (The new Pulse Time will be displayed).

PROGRAMMING

AUX2 OUTPUT OPTIONS

Only one of the P122E options may be selected.

Option No.	Description	Default
P122E 1E	Zone alarms to Aux2	ON
2E	Zone Supervision alarms to Aux2	OFF
3E	AutoTimer + R/Key Panic TOGGLES Aux2	OFF
4E	Radio Key AUX button Pulses Aux2	OFF
5E	Phone line fail to Aux2	OFF
6E	[not used]	OFF
7E	DOTL alerts to Aux2	OFF
8E	Reader output pulses Aux2	OFF

Any or all of the P142E options may be selected.

Option No.	Description	Default
P142E 1E	Area1 Armed to AUX2	OFF
2E	Area2 Armed to AUX2	OFF
3E	Home Mode arm to AUX2	OFF
4E	Keypad toggle AUX2	OFF
5E	Telephone remote control of AUX2	OFF
6E	[not used]	OFF
7E	[not used]	OFF
8E	Pulse AUX2	OFF

P122E 1E-8E

PROGRAM MODE LEVEL
Installer mode or NessComms.

FACTORY DEFAULT
1E on.

NOTES

Only one option can be on. Turning an option on turns off another.

RELATED OPTIONS

P142E 1E-8E Enhanced AUX2 options.
P354E 7E-8E AutoTimer1 AUX2 options.
P359E 7E-8E AutoTimer2 AUX2 options.
P364E 7E-8E AutoTimer3 AUX2 options.
P369E 7E-8E AutoTimer4 AUX2 options.

P122E 1E

RELATED OPTIONS
P59E Aux2 zones.

P122E 2E

RELATED OPTIONS
P65E, P66E, P67E Radio Supervision.

P122E 3E

Available in D8x/D16x V6 and later.

RELATED OPTIONS
P350E to P369E. AutoTimers 1 to 4.

P122E 4E

RELATED OPTIONS
P146E AUX2 Timer

P122E 5E

P122E 7E

RELATED OPTIONS
P303E DOTL zones.
P304E DOTL timer.

P122E 8E

RELATED OPTIONS
P318E, P328E, P338E, P319E, P329E, P339E.

AUX2 OUTPUT OPTIONS

P122E is one of several options which control the behaviour of the AUX2 output.

One of the most powerful features of the D8x/D16x panels is the flexibility to control the AUX outputs by various events and alarms. If the AUX2 output does not behave as expected, please check all related options such as AutoTimers and P142E options.

TO PROGRAM

1. Press **P122E**.
2. Press **1E ... 8E** to turn an option on. Only one option can be on.

ZONE ALARMS TO AUX2

With this option ON, zones selected in P59E will turn on Aux2 when they go into alarm. The Aux2 output turns off when the panel is disarmed/reset.

ZONE SUPERVISION ALARMS TO AUX2

Setting this option turns the AUX2 output ON when a SUPERVISED RADIO alarm is triggered. The Aux2 output turns off when the panel is disarmed/reset.

ENABLE AUX2 FOR AUTOTIMER / RADIO KEY AUX TOGGLES AUX2

Dual action programming option.

When this option is on, AUX2 is enabled for use by AutoTimer and Radio Key/s AUX button will TOGGLE the AUX2 output.

RADIO KEY AUX BUTTON PULSE AUX2

When this option is on, Radio Key/s AUX button will PULSE the Aux2 output.

TELEPHONE LINE FAULT TO AUX2

When this option is enabled, a telephone line fault condition will turn on the Aux2 output. Aux 2 will turn off when the telephone line is restored.

DOOR OPEN TOO LONG (DOTL) ALERTS TO AUX2

This option enables DOTL zones (P303E) to turn on AUX2 when the DOTL Time (P304E) expires.

READER OUTPUT TO AUX2

This option enables an access control reader to pulse Aux2 when a valid access card is presented. Set the reader using P318E, P328E or P338E.

AUX2 OUTPUT OPTIONS

P142E 1E – 8E

Available in D8x/D16x V6 and later.

PROGRAM MODE LEVEL

Installer mode or NessComms V5.3 or later.

FACTORY DEFAULT

All off.

NOTES

Any or all options may be selected on.

P142E 1E

P142E 2E

P142E 3E

P142E 4E

P142E 5E

NOTES

Remote operation by telephone procedure as detailed in the user and installation manuals must be followed before access is allowed. This includes entering a valid user code.

RELATED OPTIONS

P90E 5E, Enable remote Aux control.

P142E 8E

RELATED OPTIONS

P146E, AUX2 Pulse Time.

ENHANCED AUX2 OUTPUT OPTIONS

The P142E enhanced AUX2 options work along with P122E and AutoTimers to provide multiple choices of events and alarms to control AUX2.

TO PROGRAM

1. Press **P142E**.
2. Press **1E ... 8E** to turn an option on. Multiple options can be selected.

AREA1 ARMED TO AUX2

Turns on AUX2 while Area 1 is armed.

AREA2 ARMED TO AUX2

Turns on AUX2 while Area 2 is armed.

HOME ARMED TO AUX2

Turns on AUX2 while armed in Home mode.

KEYPAD TOGGLE AUX2

When this option is on, AUX2 is turned ON or PULSED with the keypress 22* (* = Left hand STAR button). AUX2 is turned OFF with the keypress 22# (# = Right hand STAR button).

TELEPHONE REMOTE CONTROL OF AUX2

When this option is on, AUX2 is turned ON or PULSED with the telephone keypress 22* AUX2 is turned OFF with the telephone keypress 22#

FEEDBACK TONES HEARD BY PHONE:

- 3 BEEPS: The AUX has been turned ON or is already ON.
- 1 BEEP: The AUX has been turned OFF or is already OFF.
- 1 LONG BEEP: Error. Remote AUX operation by telephone is not enabled.

PULSE AUX2

This option converts the P122E 1E and the P142E 1E, 2E, 3E, 4E, 5E options into a pulsed AUX2 output.

AUX2 is pulsed on for the time set in P146E.

Option No.	Description	Default	Note
P146E	AUX2 TIMER	20 sec	1 to 99 seconds

P146E

Available in D8x/D16x V6 and later.

PROGRAM MODE LEVEL

Installer mode or NessComms V5.3 or later.

FACTORY DEFAULT

20 sec.

RELATED OPTIONS

P142E 8E

AUX2 TIMER

Sets the length of pulse time for the AUX2 output when the P142E 8E option is selected. Select 1 to 99 seconds.

TO PROGRAM

- Press P146E (The existing Pulse Time will be displayed).
- Press [NEW TIME] E (The new Pulse Time will be displayed).

PROGRAMMING

AUX3 OUTPUT OPTIONS

Only one of the P123E options may be selected.

Option No.	Description	Default
P123E 1E	Zone Alarms to AUX3	OFF
2E	[not used]	OFF
3E	Enable AUX3 for AutoTimer	OFF
4E	Radio Key Panic Pulses AUX3	OFF
5E	[not used]	OFF
6E	[not used]	OFF
7E	[not used]	OFF
8E	Reader output pulses Aux3	OFF

Any or all of the P143E options may be selected.

Option No.	Description	Default
P143E 1E	Area1 Armed to AUX3	OFF
2E	Area2 Armed to AUX3	OFF
3E	Home Mode arm to AUX3	OFF
4E	Keypad toggle AUX3	OFF
5E	Telephone remote control of AUX3	OFF
6E	[not used]	OFF
7E	[not used]	OFF
8E	Pulse AUX3	OFF

P123E 1E

Available in D8x/D16x V8 and later.

RELATED OPTIONS

P58E Aux1,3 zones.
P121E 1E Zone Alarms to AUX1

ZONE ALARMS TO AUX3

With this option ON, zones selected in P58E will turn on Aux3 when they go into alarm. The Aux3 output turns off when the panel is disarmed/reset.

P123E 1E-8E

PROGRAM MODE LEVEL
Installer mode or NessComms.

FACTORY DEFAULT
1E on.

NOTES

Only one option can be on. Turning an option on turns off another.

RELATED OPTIONS

P143E 1E-8E Enhanced AUX3 options.
P374E 5E-6E AutoTimer1 AUX3 options.
P379E 5E-6E AutoTimer2 AUX3 options.
P384E 5E-6E AutoTimer3 AUX3 options.
P389E 5E-6E AutoTimer4 AUX3 options.

AUX3 OUTPUT OPTIONS

P123E is one of several options which control the behaviour of the AUX3 output. One of the most powerful features of the D8x/D16x panels is the flexibility to control the AUX outputs by various events and alarms. If the AUX3 output does not behave as expected, please check all related options such as AutoTimers and P143E options.

TO PROGRAM

1. Press **P123E**.
2. Press **1E ... 8E** to turn an option on. Only one option can be on.

P123E 3E

Available in D8x/D16x V8 and later.

RELATED OPTIONS
P370E to P389E. AutoTimers.

ENABLE AUX3 FOR AUTOTIMER

When this option is on, AUX3 is enabled for use by AutoTimer.

P123E 4E

Available in D8x/D16x V8 and later.

NOTES

When this option is on, Radio Key Panic buttons will no longer sound alarms or report alarms by dialler.

RELATED OPTIONS
P147E AUX3 Timer

RADIO KEY PANIC PULSES AUX3

When this option is on, Radio Key/s Panic button will PULSE the Aux3 output.

Note that P121E 4E (Radio Key Panic Pulses AUX1) over-rides this option.

P123E 8E

RELATED OPTIONS
P318E, P328E, P338E, P319E, P329E, P339E.

READER OUTPUT TO AUX3

This option enables an access control reader to pulse Aux3 when a valid access card is presented. Set the reader using P318E, P328E or P338E.

AUX3 OUTPUT OPTIONS

P143E 1E – 8E

Available in D8x/D16x V6 and later.

PROGRAM MODE LEVEL

Installer mode or NessComms V5.3 or later.

FACTORY DEFAULT

All off.

NOTES

Any or all options may be selected on.

P143E 1E

P143E 2E

P143E 3E

P143E 4E

P143E 5E

NOTES

Remote operation by telephone procedure as detailed in the user and installation manuals must be followed before access is allowed. This includes entering a valid user code.

RELATED OPTIONS

P90E 5E, Enable remote Aux control.

P143E 8E

RELATED OPTIONS

P147E, AUX3 Pulse Time.

ENHANCED AUX3 OUTPUT OPTIONS

The P143E enhanced AUX3 options work along with P123E and AutoTimers to provide multiple choices of events and alarms to control AUX3.

TO PROGRAM

1. Press **P143E**.
2. Press **1E ... 8E** to turn an option on. Multiple options can be selected.

AREA1 ARMED TO AUX3

Turns on AUX3 while Area 1 is armed.

AREA2 ARMED TO AUX3

Turns on AUX3 while Area 2 is armed.

HOME ARMED TO AUX3

Turns on AUX3 while armed in Home mode.

KEYPAD TOGGLE AUX3

When this option is on, AUX3 is turned ON or PULSED with the keypress 33* (* = Left hand STAR button). AUX3 is turned OFF with the keypress 33# (# = Right hand STAR button).

TELEPHONE REMOTE CONTROL OF AUX3

When this option is on, AUX3 is turned ON or PULSED with the telephone keypress 33* AUX3 is turned OFF with the telephone keypress 33#

FEEDBACK TONES HEARD BY PHONE:

- 3 BEEPS: The AUX has been turned ON or is already ON.
- 1 BEEP: The AUX has been turned OFF or is already OFF.
- 1 LONG BEEP: Error. Remote AUX operation by telephone is not enabled.

PULSE AUX3

This option converts the P143E 1E, 2E, 3E, 4E, 5E options into a pulsed AUX3 output. AUX3 is pulsed on for the time set in P147E.

Option No.	Description	Default	Note
P147E	AUX3 TIMER	20 sec	1 to 99 seconds

P147E

Available in D8x/D16x V6 and later.

PROGRAM MODE LEVEL

Installer mode or NessComms V5.3 or later.

FACTORY DEFAULT

20 sec.

RELATED OPTIONS

P143E 8E

AUX3 TIMER

Sets the length of pulse time for the AUX3 output when the P143E 8E option is selected. Select 1 to 99 seconds.

TO PROGRAM

- Press P147E (The existing Pulse Time will be displayed).
- Press [NEW TIME] E (The new Pulse Time will be displayed).

PROGRAMMING

AUX4 OUTPUT OPTIONS

Only one of the P124E options may be selected.

Option No.	Description	Default
P124E 1E	Zone Alarms to AUX4	OFF
2E	Enable Extension Sonalert	OFF
3E	Enable AUX4 for AutoTimer	OFF
4E	Radio Key Panic Pulses AUX4	OFF
5E	Enable AUX4 Fail To Communicate Output	OFF
6E	[not used]	OFF
7E	[not used]	OFF
8E	Reader output pulses AUX4	OFF

Any or all of the P144E options may be selected.

Option No.	Description	Default
P144E 1E	Area1 Armed to AUX4	OFF
2E	Area2 Armed to AUX4	OFF
3E	Home Mode arm to AUX4	OFF
4E	Keypad toggle AUX4	OFF
5E	Telephone remote control of AUX4	OFF
6E	[not used]	OFF
7E	[not used]	OFF
8E	Pulse AUX4	OFF

P124E 1E-8E

PROGRAM MODE LEVEL
Installer mode or NessComms.

FACTORY DEFAULT
1E on.

NOTES

Only one option can be on. Turning an option on turns off another.

RELATED OPTIONS

P143E 1E-8E Enhanced AUX4 options.
P374E 5E-6E AutoTimer1 AUX4 options.
P379E 5E-6E AutoTimer2 AUX4 options.
P384E 5E-6E AutoTimer3 AUX4 options.
P389E 5E-6E AutoTimer4 AUX4 options.

P124E 1E

RELATED OPTIONS
P59E Aux2 zones.

P122E 1E Zone Alarms to AUX2

P124E 2E

NOTES

The extension beeper can either be a standard 12V sonalert or wire directly to the Ness Quantum Sonic as shown. Keypad beeps will be heard at low volume from the Quantum Sonic's onboard siren. (Normal siren sound is unaffected).

P124E 3E

Available in D8x/D16x V6 and later.

RELATED OPTIONS
P370E to P389E. AutoTimers.

P124E 4E

Available in D8x/D16x V8 and later.

RELATED OPTIONS
P148E AUX4 Timer

P124E 5E

Available in D8x/D16x V6 and later.

RELATED OPTIONS
P370E to P389E. AutoTimers.

P124E 8E

RELATED OPTIONS
P318E, P328E, P338E, P319E, P329E, P339E.

AUX4 OUTPUT OPTIONS

P124E is one of several options which control the behaviour of the AUX4 output.

One of the most powerful features of the D8x/D16x panels is the flexibility to control the AUX outputs by various events and alarms. If the AUX4 output does not behave as expected, please check all related options such as AutoTimers and P144E options.

TO PROGRAM

1. Press **P124E**.
2. Press **1E ... 8E** to turn an option on. Only one option can be on.

ZONE ALARMS TO AUX4

With this option ON, zones selected in P59E will turn on Aux4 when they go into alarm. The Aux4 output turns off when the panel is disarmed/reset.

ENABLE EXTENSION SONALERT

Enables the Aux4 output to duplicate all keypad beeps including keypress beeps. This is useful in cases where, for example, entry beeps or other keypad beeps need to be heard in more than one location on the premises. (Adding an additional keypad would also achieve the same result).

ENABLE AUX4 FOR AUTOTIMER

When this option is on, AUX4 is enabled for use by AutoTimer.

RADIO KEY AUX PULSES AUX4

When this option is on, Radio Key/s AUX button will PULSE the Aux4 output.

ENABLE AUX4 FAIL TO COMMUNICATE OUTPUT

When this option is enabled AUX4 will turn on at the start of the fourth dialout attempt. This can be used as Fail To Communicate output to trigger backup communications devices such as GSM. The AUX4 output is automatically turned off on the next successful communication attempt or when the panel is next disarmed.

READER OUTPUT TO AUX4

This option enables an access control reader to pulse AUX4 when a valid access card is presented. Set the reader using P318E, P328E or P338E.

AUX4 OUTPUT OPTIONS

P144E 1E – 8E

Available in D8x/D16x V6 and later.

PROGRAM MODE LEVEL

Installer mode or NessComms V5.3 or later.

FACTORY DEFAULT

All off.

NOTES

Any or all options may be selected on.

P144E 1E

P144E 2E

P144E 3E

P144E 4E

P144E 5E

NOTES

Remote operation by telephone procedure as detailed in the user and installation manuals must be followed before access is allowed. This includes entering a valid user code.

RELATED OPTIONS

P90E 5E, Enable remote Aux control.

P144E 8E

RELATED OPTIONS

P148E, AUX4 Pulse Time.

ENHANCED AUX4 OUTPUT OPTIONS

The P144E enhanced AUX4 options work along with P124E and AutoTimers to provide multiple choices of events and alarms to control AUX4.

TO PROGRAM

1. Press **P144E**.
2. Press **1E ... 8E** to turn an option on. Multiple options can be selected.

AREA1 ARMED TO AUX4

Turns on AUX4 while Area 1 is armed.

AREA2 ARMED TO AUX4

Turns on AUX4 while Area 2 is armed.

HOME ARMED TO AUX4

Turns on AUX4 while armed in Home mode.

KEYPAD TOGGLE AUX4

When this option is on, AUX4 is turned ON or PULSED with the keypress 44* (* = Left hand STAR button). AUX4 is turned OFF with the keypress 44# (# = Right hand STAR button).

TELEPHONE REMOTE CONTROL OF AUX4

When this option is on, AUX4 is turned ON or PULSED with the telephone keypress 44* AUX4 is turned OFF with the telephone keypress 44#

FEEDBACK TONES HEARD BY PHONE:

- 3 BEEPS: The AUX has been turned ON or is already ON.
- 1 BEEP: The AUX has been turned OFF or is already OFF.
- 1 LONG BEEP: Error. Remote AUX operation by telephone is not enabled.

PULSE AUX4

This option converts the P144E 1E, 2E, 3E, 4E, 5E options into a pulsed AUX4 output. AUX4 is pulsed on for the time set in P148E.

Option No.	Description	Default	Note
P148E	AUX4 TIMER	20 sec	1 to 99 seconds

P148E

Available in D8x/D16x V6 and later.

PROGRAM MODE LEVEL

Installer mode or NessComms V5.3 or later.

FACTORY DEFAULT

20 sec.

RELATED OPTIONS

P144E 8E

AUX4 TIMER

Sets the length of pulse time for the AUX4 output when the P144E 8E option is selected. Select 1 to 99 seconds.

TO PROGRAM

- Press P148E (The existing Pulse Time will be displayed).
- Press [NEW TIME] E (The new Pulse Time will be displayed).

PROGRAMMING

AUX5, AUX6, AUX7, AUX8 OUTPUT OPTIONS

AUX6, 7 & 8 are programmed as per the description for AUX5.

Use the option numbers:

P151E for AUX5 output options

P152E for AUX6 output options

P153E for AUX7 output options

P154E for AUX8 output options

Option No.	Description	Default
P151E	1E [not used]	OFF
or	2E [not used]	OFF
P152E	3E [not used]	OFF
P153E	4E Keypad toggle AUX5	OFF
P154E	5E Telephone remote control of AUX5	OFF
	6E [not used]	OFF
	7E Reader Output to AUX5	OFF
	8E Pulse AUX5	OFF

P151E 4E

Available in D8x/D16x V8 and later.

PROGRAM MODE LEVEL

Installer mode or NessComms.

FACTORY DEFAULT

OFF

RELATED OPTIONS

KEYPAD TOGGLE AUX5

When this option is on, AUX5 (on the Output Expander/s) is turned ON or PULSED using the Auxiliary Control menu on the Ness Navigator touch screen keypad.

PROGRAMMING SEQUENCE:

P151E 4E toggles the option ON and OFF

OFF: Option disabled

ON: AUX5 keypad control enabled

P151E 5E

PROGRAM MODE LEVEL

Installer mode or NessComms.

FACTORY DEFAULT

OFF

RELATED OPTIONS

P90E 5E Enable remote AUX control

TELEPHONE REMOTE CONTROL OF AUX5

When this option is on, AUX5 (on the Output Expander/s) is able to be controlled by telephone remote control.

PROGRAMMING SEQUENCE:

P151E 5E toggles the option ON and OFF

OFF: Option disabled

ON: AUX5 telephone remote control enabled

P151E 7E

PROGRAM MODE LEVEL

Installer mode or NessComms.

FACTORY DEFAULT

OFF

RELATED OPTIONS

P318E, P328E, P338E, P319E, P329E, P339E

READER OUTPUT TO AUX5

This option enables an access control reader to pulse AUX5 when a valid access card is presented. Set the reader using P318E, P328E or P338E.

PROGRAMMING SEQUENCE:

P151E 7E toggles the option ON and OFF

OFF: Option disabled

ON: Access control reader output to AUX5 enabled

P151E 8E

PROGRAM MODE LEVEL

Installer mode or NessComms.

FACTORY DEFAULT

OFF

RELATED OPTIONS

P155E, P156E, P157E, P158E

PULSE AUX5

This option sets AUX5 to Pulse (momentary output) for any action that triggers AUX5 including keypad operation (see P151E 4E). Set the pulse on time using P155E.

PROGRAMMING SEQUENCE:

P151E 8E toggles the option ON and OFF

OFF: Option disabled

ON: AUX5 pulse output enabled

AUX5, AUX6, AUX7, AUX8 OUTPUT OPTIONS

Option No.	Description	Default	Note
P155E	AUX5 TIMER	20 sec	1 to 99 seconds
P156E	AUX6 TIMER	20 sec	1 to 99 seconds
P157E	AUX7 TIMER	20 sec	1 to 99 seconds
P158E	AUX8 TIMER	20 sec	1 to 99 seconds

P155E, P156E, P157E, P158E

Available in D8x/D16x V8 and later.

PROGRAM MODE LEVEL

Installer mode or NessComms V5.3 or later.

FACTORY DEFAULT

20 sec.

RELATED OPTIONS

P151E 8E Pulse AUX5

P152E 8E Pulse AUX6

P153E 8E Pulse AUX7

P154E 8E Pulse AUX8

AUX5 – AUX8 TIMERS

Sets the length of pulse time for the AUX5 – AUX8 outputs when the outputs are set for Pulse mode. Select 1 to 99 seconds.

TO PROGRAM

Press P155E, P156E, P157E or P158E (The existing Pulse Time will be displayed).

Press [NEW TIME] E (The new Pulse Time will be displayed).

Option No.	Description	Default	Note
P160E	ALARM SIREN VOLUME	99	1 to 99 levels
P161E	FIRE SIREN VOLUME	99	1 to 99 levels
P162E	CHIRP SIREN VOLUME	16	1 to 99 levels

P160E

Available in D8x/D16x V8 and later.

PROGRAM MODE LEVEL

Installer mode or NessComms V5.3 or later.

FACTORY DEFAULT

Level 99 (highest)

ALARM SIREN VOLUME

Sets the Audible Alarm volume level for the Siren output.

Select volume from 1 (lowest) to 99 (highest).

TO PROGRAM

Press P160E (The existing volume level will be displayed).

Press [NEW LEVEL] E (The new level will be displayed).

P161E

Available in D8x/D16x V8 and later.

PROGRAM MODE LEVEL

Installer mode or NessComms V5.3 or later.

FACTORY DEFAULT

Level 99 (highest)

FIRE SIREN VOLUME

Sets the Fire Alarm volume level for the Siren output.

Select volume from 1 (lowest) to 99 (highest).

TO PROGRAM

Press P161E (The existing volume level will be displayed).

Press [NEW LEVEL] E (The new level will be displayed).

P162E

Available in D8x/D16x V8 and later.

PROGRAM MODE LEVEL

Installer mode or NessComms V5.3 or later.

FACTORY DEFAULT

Level 16 (low volume)

CHIRP SIREN VOLUME

Sets the Chirp volume level for the Siren output.

Select volume from 1 (lowest) to 99 (highest).

TO PROGRAM

Press P162E (The existing volume level will be displayed).

Press [NEW LEVEL] E (The new level will be displayed).

PROGRAMMING

Option No.	Description	ZONES 1-8 (D8 & D16)								ZONES 9-16 (D16)							
		1	2	3	4	5	6	7	8	9	10	11	12	13	14	15	16
P125E	ENABLE HARDWIRED ZONES	ON	ON	ON	ON	ON	ON	ON	ON	ON	ON	ON	ON	ON	ON	ON	ON

P125E

PROGRAM MODE LEVEL
Installer mode or NessComms.
FACTORY DEFAULT
All on.

NOTES
• THIS OPTION APPLIES ONLY TO WIRED ZONES AND HAS NO EFFECT ON RADIO ZONES.

ENABLE HARDWIRED ZONES

This option allows hardwired zone inputs to be enabled or disabled. Disabled zones are ignored and do not need to be terminated with end of line resistors. This option has no effect on radio zones.

PROGRAMMING SEQUENCE:
P125E 1E-16E toggles the options ON and OFF
[Zone No]E OFF: Hardwired zones disabled for that zone
[Zone No]E ON: Hardwired zones enabled for that zone

P126E

Available in D8x/D16x V6 and later.
PROGRAM MODE LEVEL
Installer mode or NessComms V5.3 or later.
FACTORY DEFAULT
1E on. Double key Panic enabled.
2E – 5E off.
8E on.

NOTES
• One or all options can be enabled.
• To operate KPX/Saturn double key functions - in normal operating mode press and hold the matching keys for at least 1.5sec.

MISC KEYPAD OPTIONS

Various programming options for Ness KPX, Saturn and Navigator keypads.
TO PROGRAM
1. Press **P126E**.
2. Press **1E-5E** to turn an option ON or OFF.
1E, enables double key PANIC.
2E, enables double key FIRE.
3E, enables double key MEDICAL on KPX & Saturn. Enables MEDICAL on Navigator.
4E, enables Entry Chime in Day mode. Used to announce entry in Day mode.
5E, enable Chime in Home Mode. Used to announce entry in Home mode.
8E, disable One Digit At A Time Display. This allows Navigator keypads to immediately display numeric options.

P129E

Available in D8x/D16x V6 and later.
PROGRAM MODE LEVEL
Installer mode or NessComms V5.3 or later.
FACTORY DEFAULT
4E, 2.2k

NOTES
• The EOL value selected applies to all zone inputs and the external tamper input, except the keyswitch input which is always 2K2.
• The keyswitch input (if enabled) always uses a 2K2 resistor regardless of the global EOL resistor value set by P129E.
Also see P60E 2E, 3E, page 24.

END OF LINE RESISTOR OPTIONS

The End Of Line Resistor value for all zones and the external tamper can now be programmed with one of 13 different resistor values. This allows the panel to be easily retro-fitted into almost any existing installation.

TO PROGRAM
1. Press **P129E**
2. Press **1E-13E** to turn an option ON.

- | | |
|---|---------------------|
| 1E ON, 0k (The zone inputs will be Normally Closed. Open circuit to alarm). | 8E, 5.6k resistors |
| 2E, 1k resistors | 9E, 6.8k resistors |
| 3E, 1.5k resistors | 10E, 8.2k resistors |
| 4E, 2.2k resistors (Default) | 11E, 10k resistors |
| 5E, 3.3k resistors | 12E, 12k resistors |
| 6E, 3.9k resistors | 13E, 22k resistors |
| 7E, 4.7k resistors | |

AUTO-TIME FEATURES

D8x/D16x V6 onwards features sophisticated new automation features making full use of the onboard Real Time Clock and a set of powerful yet simple to program options.

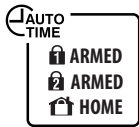

ARM or DISARM AUTOMATICALLY at pre-programmed times of day or day of the week.

This feature can save a site manager many headaches and hours of travel time. There is no need to rely on staff remembering to arm or disarm the system.

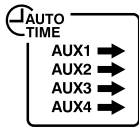

TURN OUTPUTS ON or OFF at pre-programmed times - every day, once a week, anytime. Automate doors, sprinkler systems, lights and more.



ENABLE/DISABLE USER CODES depending on the time of day or day of the week. Allows managers to grant users access to the system at selected times and deny after hours entry.

This applies to keypad codes only, not radio keys or prox fobs.

EXAMPLE 1

AREA 1 to Auto Arm Monday to Friday at 6:30pm with warning beeps 10 minutes prior to the event.

The keypad will start a slow continuous beep at 6:20pm, then at 6:29pm the beeps change to a faster rate for the final minute.

TO SILENCE THE BEEPS during the warning period. Pressing any key on the keypad will stop the beeps on the keypad (and the Reset output) and then start again for the final minute with a slightly faster beep.

TO DELAY ARMING enter a valid user code on its own. (The user code must be assigned to an Area to work). This will turn off the warning beeps and the Auto Arm for 1 hour - when the warning process will start again.

Programming Steps

AutoTimer 1			
P350E	Minutes 0-59		30
P351E	Hours 0-23		18
P352E	Days (1=Sunday)	2, 3, 4, 5, 6	
P353E	1E	AREA 1 ARM	ON
	6E	KEYPAD Beeps	ON
	8E	Extend AutoTIME	ON
P390E	AutoTime warning		10

In this example, if reporting to a central station, the arming will be sent as User 91.

EXAMPLE 2

AUX1 turns on for one minute every Saturday at 8pm.

This could be used to turn on sprinklers, a pool or spa pump, lights or anything that can be triggered by a relay output. (Requires optional 106-013 Four Relay Board).

Programming Steps

AutoTimer 2			
P355E	Minutes 0-59		00
P356E	Hours 0-23		20
P357E	Days (1=Sunday)	7	
P359E	6E	AUX1 PULSE	ON
P145E	AUX1 Pulse Time		60

TIP 1. The output can also be pulsed on (or toggled on/off) anytime using the 11* or 11# keypad commands. See page 11.

TIP 2. For longer periods (up to a week), a pair of AutoTimers can be used - one to turn the AUX ON & the other to turn it OFF.

EXAMPLE 3

User Code 56 is programmed to work only on Monday-Friday between 7am to 5pm.

The user code will be disabled outside of these times. (Applies only to keypad codes. Radio keys and prox fobs will work anytime regardless.)

Programming Steps

Enable Extra Option 9E for user code 56 to enable the user code for use by AutoTime.

EXCLUDE+E toggles Extra Options mode. See page 15.	9E Enable user Code for AutoTime
P256E	User Code 56
	ON

AutoTimer 3 Enables the user code.

AutoTimer 3			
P360E	Minutes 0-59		00
P361E	Hours 0-23		07
P362E	Days (1=Sunday)	2, 3, 4, 5, 6	
P363E	4E	Code Enable	ON

AutoTimer 4 Disables the code.

AutoTimer 4			
P365E	Minutes 0-59		00
P366E	Hours 0-23		07
P367E	Days (1=Sunday)	2, 3, 4, 5, 6	
P368E	5E	Code Disable	ON



The power and flexibility of AutoTime means it has numerous programmable options which makes **NessComms software** the ideal programming tool.

The NessComms graphical user interface makes it easy to program complex options on your PC or laptop. Then simply connect and download.

NessComms makes your life easier! See page 4 for further information.



1. For correct operation of Auto-Time features please ensure that the onboard clock is set to the current time and date. See option P340-P345E, page 70.
2. D8/D16 version 8 and later has a real time clock onboard which does not rely on external timing signals.

Option No.	Description	Default	Note
P340E	REAL TIME CLOCK SET MINUTES	00	00–59 minutes
P341E	REAL TIME CLOCK SET HOURS	00	00–23 hours (00=midnight)
P342E	REAL TIME CLOCK SET DAY	01	01–31 days
P343E	REAL TIME CLOCK SET MONTH	01	01–12 months
P344E	REAL TIME CLOCK SET YEAR	09	00–63 (2000–2063)
P345E	REAL TIME CLOCK VIEW DAY OF WEEK	1	1–7 (1=Sunday, 7=Saturday)

P340 - P345E

Available in D8x/D16x V6 and later.

PROGRAM MODE LEVEL

User Mode, Installer mode or NessComms V5.3 or later.

FACTORY DEFAULT

none

NOTES

Real Time Clock memory is regularly saved to non-volatile memory and is retained on power down.

You should always check the clock settings on power up and adjust the time and date if necessary.

REALTIME CLOCK PROGRAMMING

These options are used to program the time and date into the Realtime Clock (RTC).

TO PROGRAM

1. Press **P340E - P345E**
2. Press **[New value] E**

*LCD keypads - the programmed time is displayed one digit at a time.
Navigator keypad - the programmed time is displayed on screen*

P340E Real Time Clock minutes. Enter a value between 00 and 59. Default 00 minutes.

P341E Real Time Clock Hours. Enter a value between 00 and 23. Default 00 hours.

P342E Real Time Clock Day of the month. Enter a value between 01 and 31. Default 01, (1st day of the month). Ensure that the setting does not exceed the days in the current month. The panel does not cross-check this setting.

P343E Real Time Clock Month. Enter a value between 01 and 12. Default 01, (January).

P344E Real Time Clock Year. Enter a value between 00 and 63. (2000–2063). Default 09, (2009).

P345E Real Time Clock Day Of The Week. This value is calculated from the date. No programming is necessary. Use this option only to view the Day Of The Week. (1=Sunday). Default 1, (Sunday).

P390

Available in D8x/D16x V6 and later.

PROGRAM MODE LEVEL

Installer mode or NessComms V5.3 or later.

FACTORY DEFAULT

5 minutes

NOTES

This option sets the warning period for all AutoTimers.

RELATED OPTIONS

P353E 6E AutoTimer1, keypad beeps
P358E 6E AutoTimer2, keypad beeps
P363E 6E AutoTimer3, keypad beeps
P368E 6E AutoTimer4, keypad beeps
P373E 6E AutoTimer5, keypad beeps
P378E 6E AutoTimer6, keypad beeps
P383E 6E AutoTimer7, keypad beeps
P388E 6E AutoTimer8, keypad beeps

AUTOTIME WARNING PERIOD

This option enables a keypad beep to warn that an AutoTime action is due to begin.

Set the minutes for the start of the warning period.

The Keypad Beeps option for the required timer/s must also be enabled.

TO PROGRAM

1. Press **P390E**
2. Press **[New value] E**

The allowed range is 1 to 99 minutes.

*LCD keypads - the programmed time is displayed one digit at a time.
Navigator keypad - the programmed time is displayed on screen*

P392E 1E

Available in D8x/D16x V6 and later.

PROGRAM MODE LEVEL

Installer mode or NessComms V5.3 or later.

FACTORY DEFAULT

1E OFF

ENABLE AUTOTIME USER CODES

Toggle the current setting for the ENABLING or DISABLING of USER Codes as set by the AutoTIMERS.

If the USER codes are currently DISABLED but the current AutoTIME period means that they should be ENABLED then use this option.

TO PROGRAM

1. Press **P392E**.
2. Press **1E** to turn the option ON or OFF.
Turn the option ON to enable User codes.

P350 - P354E

Available in D8x/D16x V6 and later.

PROGRAM MODE LEVEL

Installer mode or NessComms V5.3 or later.

FACTORY DEFAULT

none

RELATED OPTIONS

P121E Enable AUX1 for AutoTimers
P122E Enable AUX2 for AutoTimers
P123E Enable AUX3 for AutoTimers
P124E Enable AUX4 for AutoTimers
P145E AUX1 Pulse Time.
P146E AUX2 Pulse Time.
P147E AUX3 Pulse Time.
P148E AUX4 Pulse Time.
P390E AutoTime Warning.
P392E Enable AutoTime User Codes
P202E - P256E Extra Option 9.
Enable user codes for AutoTime.

NOTE 1. Do not use the same AutoTimer to enable and disable user codes. For example, use AutoTimer1 to set the Code Enable time and AutoTimer2 to set the Code Disable Time.

The user codes must also be enabled for AutoTime using Extra Options for user codes.

NOTE 2. If Open/Closing reports are enabled a Closing Extended report (Contact ID 464) is sent to the control room.

NOTE 3. If Open/Closing reports are programmed, user Codes 91 to 98 are used to identify AutoTIME arming and disarming. AutoTime1 is code 91 then consecutively through to AutoTIME 8 is code 98.

NOTE 4. Note that each AutoTimer controls different AUX outputs.

NOTE 5. These instructions cover the programming of AutoTimer1. The programming for AutoTimers 2 to 8 is identical but with a different set of option numbers. See the Options Summary on page 91 for a full list of programming options for each AutoTimer.

HANDY HINT.

There are two ways to turn outputs on by AutoTimer - depending on how long the AUX output is to stay on.

1. If the ON period is less than 20 seconds then the Pulse Output option can be used to get timing periods measured in seconds. This method only requires one AutoTimer to be programmed.
2. For longer periods (up to a week), a pair of AutoTimers can be used - one to turn the AUX ON & the other to turn it OFF.

AUTOTIMER1 / AutoTimers 2-8 ^{NOTE 5}

STEP 1.

Set the the Time and Day Of The Week at which AutoTimer1 will activate.

TO PROGRAM

1. Press **P350E - P352E**. Existing value is displayed one digit at a time.
2. Press **[New value] E**. The new value is displayed one digit at a time.

P350E AutoTimer1 Minutes. Enter a value between 00 and 59.

P351E AutoTimer1 Hours. Enter a value between 00 and 23. (00 = Midnight).

P352E AutoTimer1 Day. Enter values between 1 and 7. (1E=Sunday). If the AutoTimer event is intended to take place every day, then enable all days, 1E-7E.

STEP 2.

Set the Actions which will take place on the Time and Day set above.

TO PROGRAM

1. Press **P353E or P354E**.
2. Press **1E-8E** to turn an option ON or OFF. Multiple options can be selected.

P353E

TO ENABLE AUTO-ARMING

1E Area1 Arm. Arms Area1 at the time & day set by AutoTimer1.

2E Area2 Arm. Arms Area2 at the time & day set by AutoTimer1.

3E Home Arm. Arms Home Mode at the time & day set by AutoTimer1.

Note. Option 3E enables Home Arm for AutoTimers 1 to 6 but enables Day Mode Arm for AutoTimers 7 and 8.

TO ENABLE/DISABLE USER CODES BY AUTOTIMER ^{NOTE 1}

4E Code Enable. User Codes enabled for AutoTime become active from the time set above. CODE ENABLE/DISABLE allows a period to be set on selected days of the week during which selected user codes can be used. Outside this period the codes will not work.

5E Code Disable. User Codes enabled for AutoTime are disabled at the time set above.

TO ENABLE PRE-EVENT WARNING BEEPS

6E Keypad Beeps. Turn this option on to enable the AutoTimer Warning (continuous slow beeps). The keypad/s will beep to warn that this AutoTimer is about to begin. Keypad beeps begin xx minutes before the AutoTimer is due to start as set by option P390E.

1. To **silence the beeps** during the warning period. Pressing any key on the keypad will stop the beeps on the keypad (and the Reset output) and then start again for the final minute with a slightly faster beep.
2. To **delay the AutoTime event**, enter a valid user code on its own. (The user code must be assigned to an Area to work). This will turn off the warning beeps and the Auto Arm for 1 hour - when the warning process will start again.

7E Reset Output Beeps. If 6E is ON, then this option also beeps the RESET output for a much louder AutoTimer warning if required.

8E Enable AutoTimer Extension. This allows the AutoTIME Arming ^{NOTE 2}, Code Enable & Disable and the Aux3, Aux4 actions to be delayed by entering a USER code during the Warning period.

TO ENABLE AUTO-DISARMING FOR EACH AREA ^{NOTE 3}

P354E

1E Area1 Disarm. Disarms Area1 at the time & day set by AutoTimer1.

2E Area2 Disarm. Disarms Area2 at the time & day set by AutoTimer1.

3E Home Disarm. Disarms Home Mode at the time & day set by AutoTimer1.

4E [not used]

TO CONTROL OUTPUTS BY AUTOTIMER ^{NOTE 4 & NOTE 5}

These AUX actions will take place at the time & day set by AutoTimer1.

5E AUX1 Toggle. Changes the current state of the AUX1 output. If ON then it will turn OFF and if OFF will turn ON.

6E AUX1 Pulse. Turns on the AUX1 output for a time period set P145E.

7E AUX2 Toggle. Changes the current state of the AUX2 output. If ON then it will turn OFF and if OFF will turn ON.

8E AUX2 Pulse. Turns on the AUX2 output for a time period set P146E.

Note. AUX outputs must be enabled for control by AutoTimers at options P121E-P124E.

RADIO DEVICES OPERATION

ALARM: Any Ness radio device can operate on any zone. Hardwired zones continue to operate in parallel.

Radio Keys can also operate on radio zones for special purposes, but they should normally be used as Radio Codes.

Keyswitch input: A Radio Device programmed to Zone 8 will still work as an alarm even if the Zone 8 input operation has been changed to Keyswitch operation. The P60E 2E and 3E options only affect the Zone 8 terminal inputs.

VIBRATION: Radio device zone signals IGNORE the P30E–P38E vibration sensor settings.

TAMPER REPORT: Radio Device Tamper operation depends on the Armed State of the control panel.

RADIO TAMPER: causes the keypad to continuously beep and also to flash the RADIO, TAMPER and the ZONE (identifying the detector) lights. Pressing any key on the keypad or sending a TAMPER RESTORE will clear this warning.

LOW BATTERY REPORT: A low battery gives 10 beeps and flashes the RADIO & the BATTERY light. The ZONE light identifying the radio device is also ON. The flashing lights stop when any key on the keypad is pressed or a detector code with no low battery is received. Low Battery generates HISTORY and DIALLER reports ONCE only (until the low battery is fixed and a restore report is received).

Supervision: If a zone has the P65E option ON and a radio code has been programmed for that zone, then the supervision is active. This means that the radio detector does not need to have its SUPER enabled (via header link) for the SUPERVISED timeout to occur. (Useful as an inactivity alarm). A zone supervision failure always flashes the identifying ZONE light and the RADIO light.

See pages 31-33 for more information about Zone Supervision.

NESS RADIO INTERFACE

The Ness Radio Interface (Part No. 100–200) is the optional serial radio receiver required to enable all radio functions. Connection to the control panel is via a 4 wire loom and plug supplied with the Ness Radio Interface.

NESS D8X/D16 CONTROL PANEL

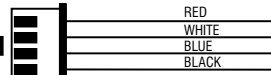

NESS RADIO INTERFACE Part No. 100–200

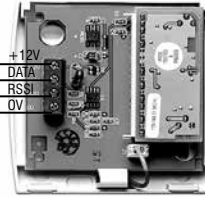

NOTES

- The Ness Radio Interface should be installed outside the control panel to prevent interference from the control panel's electronics. If the Radio Interface must be installed inside a metal enclosure, the antenna wire should protrude outside the enclosure.
- In cases where radio reception needs to be improved, the Radio Interface can be installed up to 50 metres away from the control panel. Use 14/0.20 SHIELDED cable or equivalent. The shield can either be connected to the EARTH connection or left unconnected. Leave the shield unconnected at the receiver end.
- For best performance, the antenna wire should be kept straight and not coiled, shortened or extended. An optional external antenna is available (100-046) for use in areas where the radio signal is marginal.

NOTES

- Signal strength of Radio Keys can be tested in USER PROGRAM Mode or INSTALLER PROGRAM Mode.
- Signal strength of all other Radio Devices is tested in INSTALLER PROGRAM Mode.
- PRESS 3E to test the signal strength of the selected transmitter ONLY. (Other devices will be ignored).
- PRESS 4E to test the signal strength of ANY Ness transmitter (including unprogrammed devices).

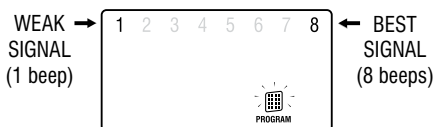

RADIO SIGNAL STRENGTH TEST

The Radio Signal Strength Test can be used to test the radio signal from any Ness radio device. The strength of the radio signal received is displayed on the zone lights 1 to 8 and beeped by the keypad.

The higher the number displayed (and beeped) the stronger the signal received.

TEST SEQUENCE:

- 1 Enter the program option for the radio device to be tested
For Radio Keys: options P201E–P256E. For Radio Devices, options P101E–P116E.
- 2 Press 3E
- 3 Trigger the radio device
 - One of zone lights 1 to 8 will turn ON to indicate the signal strength from the transmitter.
 - The Signal Strength display remains on until another command is entered.
 - To clear the display and re-test the transmitter, simply press 3E again (or 4E to test any other transmitter).

P101E – P116E

PROGRAM MODE LEVEL

Installer.

FACTORY DEFAULT

No Radio Devices programmed.

NOTES

- Radio Device programming is done by 'learning' the code by radio.
- Radio Devices codes can only be deleted by keypad.
- Some Ness Radio Devices send separate Alarm and Restore signals.
- For special purposes, radio zones can be also programmed to accept radio keys. In this case the zone can not also be programmed to accept a radio device.
- Late model Ness Radio PIRs and Radio Reed Switches send Supervision signals.

SUPERVISION RELATED OPTIONS

P65E Supervised Radio Zones.

P66E Radio Supervision Alerts.

P67E Radio Supervision Time.

P75E 12E Radio Supervision Fail Report.



106-168 LUX Radio PIR
106-170 LUX PET Radio PIR

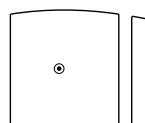

100-527
Universal Transmitter

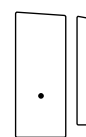

100-662
Mini Radio
Reed Switch

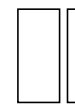

106-091
Micro Radio
Reed Switch

RADIO DEVICE PROGRAMMING

Each of the zones of the D8x or D16x can be a radio zone. Once programmed, zones can accept both radio devices and normal zone inputs simultaneously.

The optional 100-200 Ness Radio Interface is required for radio devices to operate.

A radio device is any type of Ness transmitter including Radio PIR, Radio Reed Switches, Radio Smoke Detector.

PROGRAMMING RADIO DEVICES

Up to 8 or 16 radio devices can be assigned to the D8x and D16x, (one per zone).

PROGRAMMING SEQUENCE – NO RESTORALS

Suitable for Radio PIRs, Radio Pendant, Radio Smoke Detector.

- 1 Select a zone using P101E – P116E (options P109E-P116E apply to D16 only).
The ARMED light will be ON if a Radio Device is already programmed to the zone. Or on Navigator keypad 'Radio Programmed' will display. Press 0E (or Delete Device) to delete.
- 2 **LCD KEYPAD** Press 1E (The READY light will turn ON to indicate the zone is ready to accept the Radio Device.)
NAVIGATOR KEYPAD Press Press
- 3 Send a Learn signal from the radio device by inserting the battery.
 - A. If the Radio Device is accepted, the READY light will turn off, the ARMED light will turn on and 3 beeps will sound. On the Navigator keypad 'Radio Programmed' will display.
 - B. If an error beep sounds, the Radio Device is already assigned to another zone and must be cleared from that zone first.
 - C. If SUPERVISED SIGNALS have also been successfully recognised, the TAMPER light will turn ON.

EXAMPLE: To program a Radio PIR on zone 1:

P101E 1E (or press Program Device) Insert the battery in the Radio PIR

PROGRAMMING SEQUENCE – WITH RESTORALS

Suitable for Radio Reed Switches.

- 1 Alarm the reed switch, i.e., move the magnet away from the switch
Leave the reed switch in the alarm condition and wait until radio transmission has stopped.
- 2 Select a zone using P101E – P116E
The ARMED light will be ON if a Radio Device is already programmed to the zone. Press 0E to delete.
- 3 **LCD KEYPAD** Press 1E (The READY light will turn ON to indicate the zone is ready to accept the Radio Device.)
NAVIGATOR KEYPAD Press Press
- 4 Restore the reed switch (place the magnet next to the switch)
 - A. If the Radio Device is accepted, the READY light will turn off, the ARMED light will turn on and 3 beeps will sound. On the Navigator keypad 'Radio Programmed' will display.
 - B. The MEMORY light will turn on to indicate that this device sends Restorals.
 - C. If the READY light stays on and a warning beep sounds, the Radio Device is already assigned to another zone and must be cleared from that zone first.
 - D. If SUPERVISED SIGNALS have also been successfully recognised, the TAMPER light will turn ON (LCD keypad).

EXAMPLE: To program a Radio Reed Switch with Restorals on zone 2:

Alarm the reed switch **P102E 1E (or press Program Device)** Restore the reed switch

DELETING A RADIO DEVICE:

- 1 Use P101E to P116E to select the zone
- 2 **LCD KEYPAD** Press 0E to clear the device (3 beeps will sound)
NAVIGATOR KEYPAD Press Press

RADIO DEVICES - OPTION TABLE

D8 & D16	Zone 1	P101E
	Zone 2	P102E
	Zone 3	P103E
	Zone 4	P104E
	Zone 5	P105E
	Zone 6	P106E
	Zone 7	P107E
	Zone 8	P108E
D16	Zone 9	P109E
	Zone 10	P110E
	Zone 11	P111E
	Zone 12	P112E
	Zone 13	P113E
	Zone 14	P114E
	Zone 15	P115E
	Zone 16	P116E



TIP: To prevent conflicting radio signals when programming Radio Devices, disable each device once you have finished programming it. (Remove the battery or open the RADIO link).

Remember to enable all the devices when programming is completed.

USER CODE OPTIONS TABLE

EXTRA OPTIONS MODE
(Exclude Light is on).

USER CODE	OPTION NO.	5E RADIO CODE
1 (Master)	P201E	
2	P202E	
3	P203E	
4	P204E	
5	P205E	
6	P206E	
7	P207E	
8	P208E	
9	P209E	
10	P210E	
11	P211E	
12	P212E	
13	P213E	
14	P214E	
15	P215E	
16	P216E	
17	P217E	
18	P218E	
19	P219E	
20	P220E	
21	P221E	
22	P222E	
23	P223E	
24	P224E	
25	P225E	
26	P226E	
27	P227E	
28	P228E	
29	P229E	
30	P230E	
31	P231E	
32	P232E	
33	P233E	
34	P234E	
35	P235E	
36	P236E	
37	P237E	
38	P238E	
39	P239E	
40	P240E	
41	P241E	
42	P242E	
43	P243E	
44	P244E	
45	P245E	
46	P246E	
47	P247E	
48	P248E	
49	P249E	
50	P250E	
51	P251E	
52	P252E	
53	P253E	
54	P254E	
55	P255E	
56	P256E	

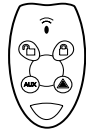

Radio Keys
100-067 RK4
106-167 RK4B
106-299 RK4P
106-178 RK3+1



100-001
Ness RKP
Radio Keypad

RADIO CODES

Each of the 56 User Codes, except for the Master Code, can be programmed to be Radio Codes. This allows up to 55 Ness Radio Keys to be used for Arming and Disarming of the panel. The Ness RKP Radio Keypad can also be used with the D8/D16, (see the RKP installer manual). The optional 100-200 Ness Radio Interface is required for radio operation.

PROGRAMMING RADIO KEYS

Use the Extra Options programming mode to enable selected user codes as Radio Codes. When a user code is enabled as a Radio Code, its Keypad Code, (if any), is automatically deleted.

PROGRAMMING SEQUENCE:

- In Installer Program Mode, enter the option number for the user code which will become a radio code. (Example, enter P256E for user code 56).
- LCD KEYPAD** Press EXCLUDE E for Extra Options mode. (Exclude light is on).
NAVIGATOR KEYPAD Press Extra Code Options.
- LCD KEYPAD** Press 5E to enable that user code as a Radio Code. (Light 5 is on).
NAVIGATOR KEYPAD Press 5 - Radio Code.
- LCD KEYPAD** EXCLUDE E to exit Extra Options mode. (The Exclude light is off).
NAVIGATOR KEYPAD Press to exit the Extra Options screen.
- LCD KEYPAD** Press 1E (The READY light will turn ON to indicate ready to accept the Radio Key)
NAVIGATOR KEYPAD Press .
If a code is already programmed the READY light will not turn on and a warning beep will sound. To clear the code, press 0E, then go back to step 5. (0E clears any existing codes).
- Press the OFF button on the Radio Key to be programmed
If the Radio Key is accepted, the READY light will turn off and 3 beeps will sound.
If the READY light stays on and a warning beep sounds, the Radio Key is already assigned to another User Code and must be cleared from that User Code first.

EXAMPLE VIA LCD KEYPAD

To enable User Code 56 as a Radio Code and program a Radio Key.

In Installer Program Mode.

Press **P256E EXCLUDE E 5E EXCLUDE E 1E** then press the OFF button on the Radio Key.

P201E – P256E

PROGRAM MODE LEVEL: Installer.

FACTORY DEFAULT: No Radio Codes, all code are keypad codes.

NOTES

- User Code 1 (Master Code) is always a Keypad Code.
- Radio Codes can be deleted by keypad in the case of a lost Radio Key.
- Radio Keys are assigned to User Codes, so that Open/Close reports are identified by user number when the control panel is base station monitored. (If Open/Close reports are enabled)

RELATED OPTIONS

P101E-P116E Programming Radio Devices.

TO DELETE A RADIO CODE:

Any Radio Code can be deleted if necessary, (lost radio key or if programming a radio key over an old one). And a Radio Code is automatically deleted when the user code type is changed to keypad code or reader code.

EXAMPLE: To delete Radio Code 56.

In Installer Program Mode: Press

LCD KEYPAD Press P256E 0E

NAVIGATOR KEYPAD Press P256E

Option No.	Description	Default	
P199E	1E	Send Address	OFF
	2E	Send Time Stamp	OFF
	3E	Send Alarms	OFF
	4E	Send Warnings	OFF
	5E	Send Access Events	OFF
	6E	Zone Seal State (D8x/D16x V6 and later)	OFF
	7E	Send Test ASCII data	OFF
	8E	[not used]	OFF

P199E

Available in D8x/D16x V5.6 and later.

PROGRAM MODE LEVEL

Installer mode or NessComms.

FACTORY DEFAULT

Options 1E-7E OFF - Serial data options disabled.

NOTES

The RS232 Serial data is output at 9600 baud, 8 data bits, no parity, 1 stop bit.

SERIAL OUTPUT OPTIONS

D8x and D16x V5.6 and later have the option for two way serial data communications via the onboard RS232 SERIAL port. Alarm and system messages can be sent and keypad/status request data can be received. This allows high level interfacing with various external devices/controllers/dataloggers and other.

Messages are in ASCII format. Due to space constraints, the full protocol is not printed in this manual but is available on request.

PROGRAMMING SEQUENCE:

P199E 1E-5E toggles the option ON and OFF

1E ON: Send Address. The address is the last digit of Acc No.2 (P73E).

2E ON: Send Time Stamp.

3E ON: Send Alarms.

4E ON: Send Warnings.

5E ON: Send Access Events.

6E ON: Send Zone Seal State. (D8x/D16x V6 and later.)

7E ON: Send test ASCII string. Sends test data periodically, used for testing the serial port (D8x/D16x V6 and later.)

P300E

PROGRAM MODE LEVEL

Installer mode or NessComms.

Option No. Description

P300E	DEFAULT ALL ACCESS CONTROL OPTIONS
-------	------------------------------------

DEFAULT ALL ACCESS CONTROL OPTIONS

Enter P300E in Installer program mode to return all access control programs to factory default values.



i If connecting multiple readers, the option to enable multiple readers (P301E 1E) should be turned on *before* programming any access cards. (Enabling P301E 1E erases existing card programming).

i If P301E 3E is enabled, a momentary push button can be wired to zone 8 as shown.

For example, this option allows the reader output to operate a door lock during the day by presenting your card. Then at the end of the day press the push button within 5 seconds of presenting the card and the panel will arm.

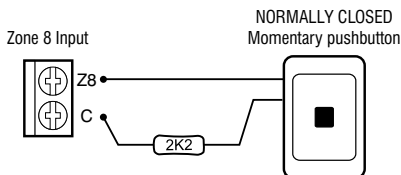
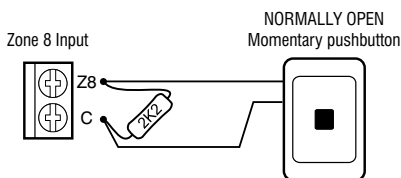

PROGRAMMING ACCESS CARDS

If the panel has 1, 2 or 3 Weigand proximity readers connected up to 55 of the panel's user codes can be programmed as Reader Codes. This allows arming/disarming by access card and operation of AUX outputs to open electric door strikes.

Use the Extra Options programming mode to enable selected user codes to Readers 1, 2 or 3. When a user code is enabled as a Reader Code, its Keypad Code, (if any), is automatically deleted. A user code enabled as a Reader Code cannot also be a Keypad Code or Radio Code.

PROGRAMMING SEQUENCE:

- 1 In Installer Program Mode, enter the option number for the user code to be programmed. (P202E–P256E).
- 2 Press EXCLUDE E to enter Extra Options mode. (Exclude light turns on).
- 3 Press 6E, 7E or 8E to assign the user code to Reader 1, 2 or 3. (Keypad light 6, 7 or 8 will turn on).
- 4 Press EXCLUDE E to exit Extra Options mode. (Exclude light turns off).
- 5 Press 1E
The keypad READY light will turn ON to indicate that the user code is ready to accept an access card. If a code is already programmed the READY light will not turn on and a warning beep will sound. To clear the code, press 0E, then go back to step 5. (0E clears any existing codes).
- 6 Present a valid access card to the reader.
If the access card is of the correct type, the reader's orange light will turn on. If the access card is accepted, the keypad READY light will turn off and 3 beeps will sound. If the READY light stays on and a warning beep sounds, the access card is already assigned to another user code and must be cleared from that user code first.

Once a card is programmed to a user code it can be used to:

ARM THE PANEL.

To allow arming with a double read, enable option P301E 2E.

To allow arming with a single read and pushbutton, enable option P301E 3E.

(Both methods can be enabled at once).

DISARM THE PANEL.

To allow disarming, (single read), enable option P301E 4E.

(This option can be enabled if necessary. A user may be allowed to arm by access card but not disarm, or vice-versa).

OPERATE AUX OUTPUT/S.

FOR EXAMPLE TO OPERATE DOORSTRIKE/S

To allow the operation of panel AUX outputs by access card, the reader to which the card is assigned must be programmed to operate one of the four AUX outputs.

- First, enable one or more AUX outputs to be a Reader output, P121E 8E, P122E 8E, P123E 8E and P124E 8E.
- If using more than one 101-014 Ultraprox Reader, enable P301E 1E to Use Reader Addresses.
- Next, assign which reader will trigger which AUX output. P318E - P338E

Option No.	Description	Default	
P301E	1E	Use reader addresses	OFF
	2E	Arm with double read	ON
	3E	Arm with single read and pushbutton	OFF
	4E	Disarm with access card	ON
	5E	REX Input 1 (Zone 5 input)	OFF
	6E	REX Input 2 (Zone 6 input)	OFF
	7E	REX Input 3 (Zone 7 input)	OFF
	8E	Strobe Flash on Arm/Disarm by Reader	ON

P301E 1E

PROGRAM MODE LEVEL

Installer mode or NessComms.

FACTORY DEFAULT

OFF (Use one reader).

NOTES

When using multiple readers, this option must be enabled before programming any access cards, (to avoid losing card programming when the option is enabled).

P301E 2E

PROGRAM MODE LEVEL

Installer mode or NessComms.

FACTORY DEFAULT

ON.

P301E 3E

PROGRAM MODE LEVEL

Installer mode or NessComms.

FACTORY DEFAULT

OFF.

NOTES

- When this option is enabled, zone 8 is automatically disabled as an alarm zone.

P301E 4E

PROGRAM MODE LEVEL

Installer mode or NessComms.

FACTORY DEFAULT

ON.

P301E 5E-7E

PROGRAM MODE LEVEL

Installer mode or NessComms.

FACTORY DEFAULT

OFF.

NOTES

- When one of these options is enabled, that zone is automatically disabled as an alarm zone.
- The zone must reseal before another Request To Exit can occur. i.e. If the zone is left unsealed, the door will not be left unlocked.

RELATED OPTIONS

P37E, P38E Long Response Zones

P318E, P328E, P338E, P121E-P124E

Programming of Readers to Aux outputs.

USE READER ADDRESSES

If ON then all readers connected to the D8x/D16x must have set addresses of 1, 2 or 3. The data is then sent in an extended format that includes the reader address. (Use up to three Ness prox readers). The reader's address is determined the connection of the violet wire. See the wiring diagram on page 82).

If this option is off, one standard Weigand 26bit reader can be used. The reader's actions are determined by the P318E, P319E Reader 1 options.

PROGRAMMING SEQUENCE:

P301E 1E toggles the option ON and OFF

OFF: Do not use Reader addresses **ON:** Use Reader addresses

ARM WITH DOUBLE READ

When this option is enabled the panel will arm if *the same* valid access card is presented to a reader twice within 5 seconds.

PROGRAMMING SEQUENCE:

P301E 2E toggles the option ON and OFF

OFF: Do not Arm With Double Read **ON:** Arm With Double Read

ARM WITH SINGLE READ AND PUSHBUTTON

When this option is enabled the panel will arm if a valid access card is presented to a reader once and zone 8 is unsealed momentarily within 5 seconds.

This option can be used to prevent accidental arming or disarming by access card.

PROGRAMMING SEQUENCE:

P301E 3E toggles the option ON and OFF

OFF: Do not Arm With Single Read and Pushbutton **ON:** Arm With Single Read and Pushbutton

DISARM WITH ACCESS CARD

When this option is enabled a valid access card will disarm the panel. (It will perform the same function as a keypad code + E or a radio key off button).

PROGRAMMING SEQUENCE:

P301E 4E toggles the option ON and OFF

OFF: Do not Disarm with access card **ON:** Disarm with access card

REQUEST TO EXIT (REX) INPUTS

These options convert zones 5, 6 and 7 into Request To Exit (REX) inputs for access control, allowing for push button door exit. Connect a N/C or N/O pushbutton to either open circuit or short circuit the zone resistor.

The REX zones can also be programmed as Long Response Zones (P37E, P38E) to prevent accidental door opening, the REX button must be pressed and held for 1sec or 3sec, as programmed.

P301E 5E enables Zone 5 to trigger the AUX outputs assigned to Reader1.

P301E 6E enables Zone 6 to trigger the AUX outputs assigned to Reader2.

P301E 7E enables Zone 7 to trigger the AUX outputs assigned to Reader3.

PROGRAMMING SEQUENCE:

P301E 5E, 6E or 7E toggles the option ON and OFF

OFF: The zone is a normal alarm zone

ON: The zone is a REX input

P301E 8E

Available in D8x/D16x V5.3 and later.

PROGRAM MODE LEVEL

Installer mode or NessComms.

FACTORY DEFAULT

ON

STROBE FLASH ON ARM/DISARM BY READER

This option enables strobe flash when arming and disarming by Reader. (D8x/D16x versions prior to V5.4 had strobe flash permanently enabled).

PROGRAMMING SEQUENCE:

P301E 8E toggles the option ON and OFF

OFF: Strobe flash disabled **ON:** Strobe flash enabled

Option No.	Description	ZONES 1-8 (D8 & D16)								ZONES 9-16 (D16)							
		1	2	3	4	5	6	7	8	9	10	11	12	13	14	15	16
P303E	DOTL ZONES																

P303E

PROGRAM MODE LEVEL

Installer mode or NessComms.

FACTORY DEFAULT

All OFF: No DOTL zones.

NOTES

Zones can be assigned as DOTL zones in addition to normal alarm functions. Therefore, DOTL zones can operate as alarm zones when armed and DOTL zones when disarmed. (Day Zone programming still applies).

DOOR OPEN TOO LONG (DOTL) ZONES

This selects the zones that will generate a DOTL alert if the zone is unsealed for longer than the time set by P304E.

The types of alerts are set by P121E 7E, P122E 7E and P305E.

PROGRAMMING SEQUENCE:

P303E 1E-16E toggles the options ON and OFF

OFF: DOTL is disabled for that zone

ON: DOTL is enabled for that zone

Option No.	Description	Default	Note
P304E	DOTL TIME	20	01-99 seconds

P304E

PROGRAM MODE LEVEL

Installer mode or NessComms.

FACTORY DEFAULT

20 seconds.

DOTL TIME

Sets the delay time in seconds before a DOTL zone generates a DOTL alert. Enter a value between 01 and 99.

PROGRAMMING SEQUENCE:

P304E existing DOTL time is displayed one digit at a time

[ENTER NEW VALUE] E new value is displayed one digit at a time

Option No.	Description	Default
P305E 1E	DOTL output LATCHES	OFF
2E	DOTL outputs to Output Expander	OFF
3E	DOTL Timer in Minutes	OFF
4E	DOTL Timer in Hours	OFF
5E	DOTL zone flashes on keypad	OFF
6E	[not used]	OFF
7E	[not used]	OFF
8E	[not used]	OFF

PROGRAM MODE LEVEL

Installer mode or NessComms.

PROGRAMMING SEQUENCE:

P305E [1E-8E] toggles the options ON and OFF

P305E 1E

RELATED OPTIONS

P121E 7E DOTL Alerts to Aux1.
P122E 7E DOTL Alerts to Aux2.

DOTL OUTPUT LATCHES

With this option on, DOTL alerts will either follow the sealed/unsealed state of DOTL zones or latch the Aux output/s which have been programmed for DOTL alerts.

- 1E OFF: DOTL Outputs follow the state of DOTL zones set by P303E. (Factory default).
- 1E ON: DOTL Outputs latch on until reset by disarming the panel.

P305E 2E

RELATED OPTIONS

P117E 1E Enable Output Expander.

DOTL ALERTS TO OUTPUT EXPANDER

With this option on, DOTL alerts will be sent to the optional Output Expander on the same output number as the DOTL zone number. P305E 1E settings apply.

- 2E OFF: No DOTL Alerts to the Output Expander. (Factory default).
- 2E ON: DOTL Alerts sent to the Output Expander.

P305E 3E

Available in D8x/D16x V8 and later.

DOTL TIMER IN MINUTES

Changes the P304E timer to minutes to give the option for longer DOTL times.

- 3E OFF: DOTL Timer in seconds. (Factory default).
- 3E ON: DOTL Timer in minutes.

P305E 4E

Available in D8x/D16x V8 and later.

DOTL TIMER IN HOURS

Changes the P304E timer to hours to give the option for extra long DOTL times.

- 4E OFF: DOTL Timer in seconds or minutes as set by P305E 3E. (Factory default).
- 4E ON: DOTL Timer in hours.

P305E 5E

DOTL ALERTS TO KEYPAD

With this option on, DOTL alerts will SLOWLY Flash the corresponding zone light on the keypad. P305E 1E settings apply.

- 5E OFF: No DOTL Alerts to the Keypad. (Factory default).
- 5E ON: DOTL Alerts slow flash zone lights on the Keypad..

Option No.	Description	Default	
P318E	1E	Ultraprox Reader1 to AUX1	OFF
	2E	Ultraprox Reader1 to AUX2	OFF
	3E	Ultraprox Reader1 to AUX3	OFF
	4E	Ultraprox Reader1 to AUX4	OFF
	5E	Ultraprox Reader1 to AUX5	OFF
	6E	Ultraprox Reader1 to AUX6	OFF
	7E	Ultraprox Reader1 to AUX7	OFF
	8E	Ultraprox Reader1 to AUX8	OFF
P319E	Ultraprox Reader1 output TIME	5 sec	
P328E	1E	Ultraprox Reader2 to AUX1	OFF
	2E	Ultraprox Reader2 to AUX2	OFF
	3E	Ultraprox Reader2 to AUX3	OFF
	4E	Ultraprox Reader2 to AUX4	OFF
	5E	Ultraprox Reader2 to AUX5	OFF
	6E	Ultraprox Reader2 to AUX6	OFF
	7E	Ultraprox Reader2 to AUX7	OFF
	8E	Ultraprox Reader2 to AUX8	OFF
P329E	Ultraprox Reader2 output TIME	5 sec	
P338E	1E	Ultraprox Reader3 to AUX1	OFF
	2E	Ultraprox Reader3 to AUX2	OFF
	3E	Ultraprox Reader3 to AUX3	OFF
	4E	Ultraprox Reader3 to AUX4	OFF
	5E	Ultraprox Reader3 to AUX5	OFF
	6E	Ultraprox Reader3 to AUX6	OFF
	7E	Ultraprox Reader3 to AUX7	OFF
	8E	Ultraprox Reader3 to AUX8	OFF
P339E	Ultraprox Reader3 output TIME	5 sec	

PROGRAM MODE LEVEL

Installer mode or NessComms.

NOTES

AUX outputs 5–8 are available only in D8x/D16x version 8 and later.

READERS 1–3 to AUX OUTPUTS 1–8

These options give the flexibility of assigning any access reader to any Aux output for operating door strikes, magnetic locks, etc. Readers can be assigned to multiple outputs. Always use an external relay board (101-283) on each Aux output on the output expander/s if connecting devices which draw more than 100mA.

P318E 1E–8E

RELATED OPTIONS

P121E 8E, P122E 8E, P123E 8E, P124E 8E, P151E 7E, P152E 7E, P153E 7E, P154E 7E, P319E, P329E, P339E

P318E [1E–8E] *Toggles the options.*

1E ON: Reader 1 output to **Aux1** (P121E 8E must also be on)
 2E ON: Reader 1 output to **Aux2** (P122E 8E must also be on)
 3E ON: Reader 1 output to **Aux3** (P123E 8E must also be on)
 4E ON: Reader 1 output to **Aux4** (P124E 8E must also be on)
 5E ON: Reader 1 output to **Aux5** (P151E 7E must also be on)
 6E ON: Reader 1 output to **Aux6** (P152E 7E must also be on)
 7E ON: Reader 1 output to **Aux7** (P153E 7E must also be on)
 8E ON: Reader 1 output to **Aux8** (P154E 7E must also be on)

P328E 1E–8E

RELATED OPTIONS

P121E 8E, P122E 8E, P123E 8E, P124E 8E, P151E 7E, P152E 7E, P153E 7E, P154E 7E, P319E, P329E, P339E

P328E [1E–8E] *Toggles the options.*

1E ON: Reader 2 output to **Aux1** (P121E 8E must also be on)
 2E ON: Reader 2 output to **Aux2** (P122E 8E must also be on)
 3E ON: Reader 2 output to **Aux3** (P123E 8E must also be on)
 4E ON: Reader 2 output to **Aux4** (P124E 8E must also be on)
 5E ON: Reader 2 output to **Aux5** (P151E 7E must also be on)
 6E ON: Reader 2 output to **Aux6** (P152E 7E must also be on)
 7E ON: Reader 2 output to **Aux7** (P153E 7E must also be on)
 8E ON: Reader 2 output to **Aux8** (P154E 7E must also be on)

P338E [1E–8E] *Toggles the options.*

1E ON: Reader 3 output to **Aux1** (P121E 8E must also be on)
 2E ON: Reader 3 output to **Aux2** (P122E 8E must also be on)
 3E ON: Reader 3 output to **Aux3** (P123E 8E must also be on)

P338E 1E-8E**RELATED OPTIONS**

P121E 8E, P122E 8E, P123E 8E,
 P124E 8E, P151E 7E, P152E 7E,
 P153E 7E, P154E 7E, P319E, P329E,
 P339E

4E ON: Reader 3 output to **Aux4** (P124E 8E must also be on)
 5E ON: Reader 3 output to **Aux5** (P151E 7E must also be on)
 6E ON: Reader 3 output to **Aux6** (P152E 7E must also be on)
 7E ON: Reader 3 output to **Aux7** (P153E 7E must also be on)
 8E ON: Reader 3 output to **Aux8** (P154E 7E must also be on)

P319E, P329E, P339E**PROGRAM MODE LEVEL**

Installer mode or NessComms.

RELATED OPTIONS

P318E, P328E, P338E.

READERS 1-3 OUTPUT TIME

This sets the time that the outputs selected by P318E, P328E and P338E are ON.
 Range 1-24 seconds.

PROGRAMMING SEQUENCE:

P319E, P329E or **P339E** existing *Reader Output Time* is displayed one digit at a time
[ENTER NEW VALUE] E *new value* is displayed one digit at a time

WIRING A SINGLE READER

P301E 1E is OFF (Reader addresses not used)

Connect only 1 reader.

In this mode the panel is compatible with the Ness 101-014 Ness Ultraprox Weigand Reader.

i Recommended cable is twisted 3 pair shielded cable with only one end of the shield connected to ground. For cable runs exceeding 75m use the Ness Weigand data repeater.

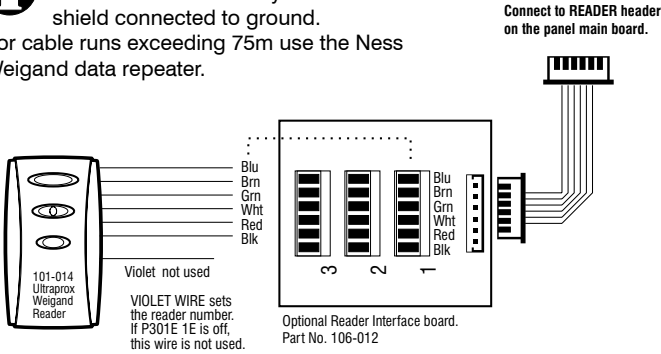

WIRING A DOOR STRIKE

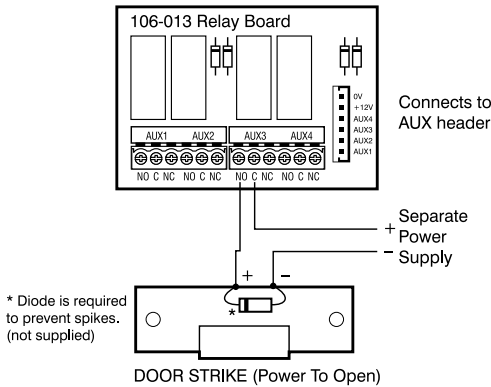

WIRING MULTIPLE READERS

P301E 1E is ON (Use Reader addresses)

When multiple readers are used, the panel needs to identify the individual readers.

The 101-014 Ness Ultraprox Weigand Readers can be addressed as Reader 1, 2 or 3 by connecting the Violet wire to an appropriate terminal.

You can setup 3 x 101-014 readers with individual addresses or setup one or more readers with the same address.

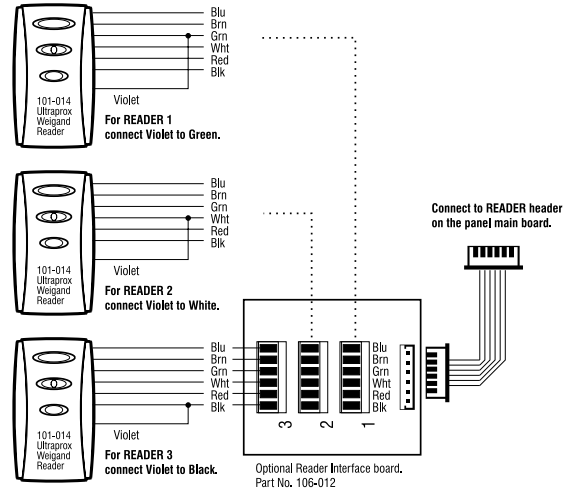

REQUEST TO EXIT (REX) USING A KEYPAD CODE

Codes selected for Code Only Arming can be used as REX codes for access control functions. That is, the code can operate an output instead of arming/disarming the panel.

There are two conditions needed to make the code operate as a REX code - It is assigned to CODE ONLY ARM and it is not assigned to either Area 1 or Area 2.

The first digit of the user code determines which AUX output is operated by the REX code. That is, a REX code in the format 1xxx operates AUX1, 2xxx operates AUX2 and 3xxx operates AUX3.

Notes:

1. Reader 1 can also use codes starting with 4-9 if only one exit point is used.
2. Set P318E, P328E, P338E options to select appropriate AUX outputs.
3. Set corresponding P121E, P122E, P123E, P124E options to 8E.

Setup Example:

- User Codes 1555, 2555, 3555 are programmed to be Code Only Arm and are not assigned to Area 1 or Area 2.
- P318E 1E, P328 2E, P338 3E are programmed to set reader output to selected Aux output.
- P121E 8E, P122E 8E, P123E 8E are programmed to set AUX outputs to reader.

Operation Example:

- Code 1555 activates door associated with AUX1 (READER 1).
- Code 2555 activates door associated with AUX2 (READER 2).
- Code 3555 activates door associated with AUX3 (READER 3).

CENTRAL STATION MONITORING

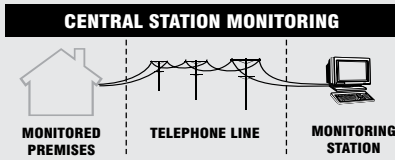

The Ness D8x and D16x control panels have an on-board landline dialler which can send detailed alarm messages to a central monitoring station.

The digital messages can include information about the zone/s which caused the alarm, tamper alarms, low battery or mains failure reports, and it can also (by user number) identify the users who arm and disarm the system.

Central station monitoring is highly recommended and is the most effective method of monitoring your alarm system.

Installers are welcome to contact Ness for further information about monitoring.

AUDIBLE MONITORING

Note that the operation of Audible Monitoring has changed over several revisions of D8/D16 control panels

D8/D16 REVISION	AUDIBLE MONITORING TYPE
Prior to V5.6	Audible beeps
V5.6 – V7.8	Audible beeps and spoken word "Alarm"
V8.0 and later	Extensive library of spoken word messages for audible monitoring and spoken prompts for remote phone operation

This section applies to

V8.0 and later

AUDIBLE VOICE MONITORING - ENHANCED

D8x/D16x version 8.0 and later has enhanced audible monitoring features using an onboard library of voice messages to deliver clear and concise spoken word alarm messages to the recipient's mobile phone or landline.

Audible messages are detailed and interactive, with spoken word messages clearly stating the alarm condition being reported. The user can then acknowledge the alarm and hang up or enter a remote control menu which gives options to arm and disarm the system, control auxiliary outputs and even exclude zones - all over the phone.

ALARM MESSAGE TRANSMISSION

Alarm reports are sent to the Primary (P70E) and Secondary (P71E) telephone numbers or only to the Follow Me phone number (P00E) if programmed.

ALARM MESSAGE FORMAT

The alarm message starts with the introduction:

☎ This is a security system message. To start the report press 1.

The recipient must press 1 on their phone. If not, the message repeats.

☎ [System Name] security system reports the following

System Name is programmed by option P198E

☎ [Alarm or Message] (See the Voice Messages table)

☎ Wait to hear the report again, or to continue, press 1.

Press 1 on your phone. More alarm reports, if any, are heard.

Once all alarms have been acknowledged.

☎ End of messages. To control the security system press 2 then, after the tone press 2 again. To acknowledge and end, press STAR then press HASH and then hang up the phone.

Press STAR then HASH to hang up.

Press 2 then 2 to continue to the telephone remote control menu. See page 85.

P198E

Available in D8x/D16x V8 and later.

PROGRAM MODE LEVEL

Installer mode or NessComms V5.3 or later.

FACTORY DEFAULT

11E on

NOTES

Only one option can be on. Turning an option on turns off another.

SYSTEM NAME

Assign a name to the control panel to identify the system during an audible alarm message.

You can program a name from the choice below.

TO PROGRAM

1. Press **P198E**
2. Press **1E-11E** to turn an option ON.
 - 1E "Home"
 - 2E "Office"
 - 3E "Work"
 - 4E "Family 1"
 - 5E "Family 2"
 - 6E "Family 3"
 - 7E "System 1"
 - 8E "System 2"
 - 9E "System 3"
 - 10E "Ness Security System"
 - 11E "Ness Corporation"

VOICE MESSAGE LIBRARY

D8x/D16x version 8.0 audible alarm messages and voice prompts for remote phone operation are drawn from this built-in library of pre-recorded voice messages.

DESCRIPTION	VOICE MESSAGE
ALARM MESSAGES	
ZONE 1 to ZONE 16	Zone 1 alarm ... Zone 16 alarm.
Duress	Duress EMERGENCY.
Keyswitch Panic	Keyswitch panic emergency.
Keypad Panic	Keypad panic emergency.
Radio Panic	Radio panic emergency.
Medical alarm	Medical EMERGENCY.
Fire alarm	Fire EMERGENCY.
Exit installer	Exit installer WARNING.
External Tamper	External tamper warning.
Internal Tamper	Security system Main Tamper WARNING.
Keypad Tamper	Keypad tamper warning.
Radio Tamper	Radio detector Tamper WARNING.
Mains Fail	Mains power Fail WARNING.
Panel Bat Fail	Security system main Battery Fail WARNING.
RADIO Bat Fail	Radio battery fail warning.
RADIO Super Fail	RADIO detector Supervision Fail WARNING.
ALARM INTRO	This is a security system report. To start the report press 1.
ALARM LOCATION	Security SYSTEM reports the following:
ALARM CONCLUSION	End of messages. To control the security system press 2, then after the tone, press 2 again. To acknowledge and end, press STAR, then press HASH, and then hang up the phone.
TELEPHONE REMOTE CONTROL MESSAGES	
REMOTE CONTROL ANSWER INTRO	This is your SECURITY SYSTEM.
REMOTE CONTROL Entry Fail	Please try again. Press STAR, then enter your USER code, then PRESS HASH.
CONTROL INTRO	To arm or disarm the security system press 1. To control OUTPUTS press 2. To exclude or include a zone press 3. To listen to reports press 4. To hang up, press STAR then press HASH.
ARM & DISARM INTRO	To arm, press 1. To disarm, press 2. To return, press STAR
ARMED 1	Area 1 armed
ARMED 2	Area 2 armed
DISARMED 1	Area 1 disarmed
DISARMED 2	Area 2 disarmed

DESCRIPTION	VOICE MESSAGE
CONTROL OUTPUTS INTRO	Double press the selected auxiliary output 1 to 8. Then press STAR to activate or HASH to turn off the selected output. Press STAR to return.
AUX 1 ON	Auxiliary 1 ON.
AUX 2 ON	Auxiliary 2 ON.
AUX 3 ON	Auxiliary 3 ON.
AUX 4 ON	Auxiliary 4 ON.
AUX 5 ON	Auxiliary 5 ON.
AUX 6 ON	Auxiliary 6 ON.
AUX 7 ON	Auxiliary 7 ON.
AUX 8 ON	Auxiliary 8 ON.
AUX 1 OFF	Auxiliary 1 OFF.
AUX 2 OFF	Auxiliary 2 OFF.
AUX 3 OFF	Auxiliary 3 OFF.
AUX 4 OFF	Auxiliary 4 OFF.
AUX 5 OFF	Auxiliary 5 OFF.
AUX 6 OFF	Auxiliary 6 OFF.
AUX 7 OFF	Auxiliary 7 OFF.
AUX 8 OFF	Auxiliary 8 OFF.
EXCLUDE ALARMS INTRO	To TOGGLE the zone EXCLUSION, enter the zone number, then press HASH.
ACKNOWLEDGE	Wait to hear the report again, or to continue, press 1.
LISTEN TO REPORTS INTRO	To listen to the zone report, press 1. To listen to the emergencies and warnings report, press 2. To listen to the AREA ARM report press 3. To listen to the excluded zone report press four.
ZONE REPORT LIST	The following zone alarms are current:
WARNING REPORT LIST	The following EMERGENCIES and WARNINGS are current:
EXCLUDE REPORT LIST	The following zone exclusions are current:
RADIO DEVICE LOW BATTERY	A radio device has a low battery and needs to be changed.
EXTERNAL SIREN TAMPER	The external siren cover has been tampered with.
PANEL ENCLOSURE TAMPER	The security system main enclosure has been tampered with.
All OK	All OK.
INVALID	Invalid entry.
RETURN PROMPT	To return press HASH.

TELEPHONE REMOTE CONTROL

for V8.0 and later

P90E 1E must be enabled for Telephone Remote Control to work. See page 50.

TO CONNECT TO THE PANEL BY TELEPHONE

METHOD 1. The connection is initiated by the panel during an alarm message. See page 83.

METHOD 2. The connection is initiated by the user phoning the panel.

HOW TO INITIATE TELEPHONE REMOTE CONTROL

1. Phone the panel telephone number and listen for the required number of rings (the normal double ring is counted as one ring) and then hang up.
2. Wait 10 seconds and then call the number again within 50 seconds.
3. The panel will answer the second call immediately and respond with an audible tone similar to a fax tone.
4. Press the **[2]** button on your telephone to start the session.
5. Listen to the voice prompts for instructions.
6. When you're done, press **[*]** **[#]** to hang up.

Remote operation allows:

1. Control of Arming/Disarming, AUX 1 to AUX 8 and Zone Excludes.
 2. Voice updates on Arming state, Zone alarm and excluded state, warning states.
- Prompts would be issued when one of these is changed.

OPERATION

Example:

When the user calls the panel using the accepted methods and after the panel stops sending the answer tone sequence.

The user first presses key 3 and the panel starts the voice prompt:

☎) This is your SECURITY SYSTEM.

To control the security system press STAR, then enter your USER code, then press HASH.

If the user does this correctly then the voice prompt continues:

☎) To arm or disarm the system press 1. To control OUTPUTS press 2. To exclude or include a zone press 3. To listen to reports press 4. To hang up press STAR then PRESS HASH.

The user presses 1 to arm or disarm the system and the voice prompt continues:

☎) To arm, Press 1. To disarm, Press 2. To return, Press STAR.

The user presses 1 to arm and the voice prompt continues with either of these messages:

EITHER

(assuming Area 1 was disarmed and that Area 2 is not remote armed)

☎) Area 1 armed, Area 2 disarmed, To arm or disarm the security system press 1.

To control OUTPUTS press 2. To exclude or include a zone press 3. To listen to reports press 4. To hang up press STAR then press HASH.

OR

(assuming Area 1 was already armed)

☎) Invalid entry. To arm or disarm the security system press 1. To control OUTPUTS press 2. To exclude or include a zone press 3. To listen to reports press 4. To hang up press STAR then press HASH.

The user presses 2 to control outputs and the voice prompt continues with the message:

☎) Double press the selected auxiliary output 1 to 8. Then press STAR to activate or HASH to turn off the selected output. Press STAR to return.

The user presses 33 STAR * and the voice prompt continues:

☎) Auxiliary 3 ON

The user presses 33 HASH # and the voice prompt continues:

☎) Auxiliary 3 OFF

The user presses 32 HASH (#) (Note that this is an incorrect sequence) and the voice prompt continues:

☎) To arm or disarm the security system press 1. To control OUTPUTS press 2. To exclude or include a zone press 3. To listen to reports press 4. To hang up press STAR then press HASH.

The user presses STAR then HASH (* then #) to hangup.



**USER CODE
OPTIONS TABLE**

EXCLUDE+E toggles Extra Options mode.
(Installer Program mode only)

USER CODE U	OPTION NO.	KEYPAD PIN	PAGE 14, 15									Page 74	Page 76			Page 15, 69		
			1E AREA 1 Code	2E AREA 2 Code	3E ARM ONLY	4E "CODE ONLY" ARM (REX CODE)	5E RADIO Code	6E Reader 1 Code	7E Reader 2 Code	8E Reader 3 Code	9E Enable for AutoTime							
1 (Master)	P201E	123	ON	ON														
2	P202E		ON															
3	P203E		ON															
4	P204E		ON															
5	P205E		ON															
6	P206E		ON															
7	P207E		ON															
8	P208E		ON															
9	P209E		ON															
10	P210E		ON															
11	P211E		ON															
12	P212E		ON															
13	P213E		ON															
14	P214E		ON															
15	P215E		ON															
16	P216E		ON															
17	P217E		ON															
18	P218E		ON															
19	P219E		ON															
20	P220E		ON															
21	P221E		ON															
22	P222E		ON															
23	P223E		ON															
24	P224E		ON															
25	P225E		ON															
26	P226E		ON															
27	P227E		ON															
28	P228E		ON															
29	P229E		ON															
30	P230E		ON															
31	P231E		ON															
32	P232E		ON															
33	P233E		ON															
34	P234E		ON															
35	P235E		ON															
36	P236E		ON															
37	P237E		ON															
38	P238E		ON															
39	P239E		ON															
40	P240E		ON															
41	P241E		ON															
42	P242E		ON															
43	P243E		ON															
44	P244E		ON															
45	P245E		ON															
46	P246E		ON															
47	P247E		ON															
48	P248E		ON															
49	P249E		ON															
50	P250E		ON															
51	P251E		ON															
52	P252E		ON															
53	P253E		ON															
54	P254E		ON															
55	P255E		ON															
56	P256E		ON															

OPTION	DESCRIPTION	DEFAULT	PAGE	
P00E U	Follow Me Telephone Number.	none	38	
P26E U	ENTRY DELAY Time 1	20 sec	16	
P27E U	Entry Delay Time 2	6=60 sec		
P28E U	EXIT DELAY Time	60 sec		
P29E	SIREN RESET Time	5 min		
P30E	Normal Zone Sensitivity	all zones	17	
P31E-36E	Vibration Sensitivity, High-Low	none		
P37E	Long Response Zones - 1 second	none		
P38E	Long Response Zones - 3 seconds	none		
P39E	Double Trigger zones	none	18	
P40E	Instant zones	zones 3+		
P41E	ENTRY DELAY 1 zones	Zone 1		
P42E	HANDOVER zones	Zone 2		
P43E	Entry Delay 2 zones	none	19	
P44E	Lockout zones (RESET output)	All zones		
P45E	AREA 1 zones	All zones		
P46E	AREA 2 zones	none		
P51E	HOME MODE zones	none	21	
* See page 20 for information on Area operation, Home mode & Temporary Day Zones			20	
P52E	24hr zones	none	21	
P53E	Day Mode zones	none		
P54E	RESET output zones	All zones	22	
P55E	STROBE zones	All zones		
P56E	Keypad Sonalert zones	All zones		
P57E	SIREN zones	All zones		
P58E	Aux1 / Aux3 zones	none	23	
P59E	Aux2 / Aux4 zones	none		
P60E	1E	Entry Beeps	ON	24, 25
	2E	Keyswitch Home Monitor/Disarm	OFF	
	3E	Keyswitch Arm/Disarm	OFF	
	4E	Tamper Siren lockout	ON	
	5E	Duress to RESET output	OFF	
	6E	Auto Exclude zones	ON	
	7E	Auto keypad display off	OFF	
	8E	Delayed Aux3, Aux4 outputs	OFF	
P61E	1E	Tamper to RESET output	ON	26
	2E	Tamper to STROBE output	ON	
	3E	Tamper to Keypad Sonalert	ON	
	4E	Tamper to SIREN output	ON	
	5E	Keypad Panic to RESET output	ON	
	6E	Keypad Panic to STROBE output	ON	
	7E	Keypad Panic to Sonalert	ON	
	8E	Keypad Panic to SIREN output	ON	



Options marked "u" can be programmed in User Program Mode



All options can be programmed in Installer Program Mode

OPTION	DESCRIPTION	DEFAULT	PAGE	
P62E	1E	Shortcut Memory display	ON	27
	2E	Shortcut Zone Exclude	ON	
	3E	Shortcut Home Mode	ON	
	4E	Shortcut Keypad Panic	OFF	
	5E	Shortcut Area1 Arming	ON	
	6E	Shortcut Area2 Arming	OFF	
	7E	Brief warning on Auto Exclude	ON	
	8E	Exit Time x10	OFF	
P63E	1E	Home Mode alarms to RESET output	ON	28
	2E	Home Mode alarms to STROBE	ON	
	3E	Home Mode alarms to SONALERT	ON	
	4E	Home Mode alarms to SIREN	OFF	
	5E	Day Mode to RESET output	ON	
	6E	Day Mode to STROBE	OFF	
	7E	Day Mode KP SONALERT (Chime KPX)	OFF	
	8E	Day Mode to SIREN	OFF	
P64E	1E	Brief Home Mode Alarm	OFF	29, 30
	2E	Brief Day Alarm	OFF	
	3E	Home zones Entry Delay2	ON	
	4E	Radio Key SIREN CHIRPS	OFF	
	5E	[not used]	ON	
	6E	Strobe Flash on Home arm by radio	OFF	
	7E	[not used]	OFF	
	8E	[not used]	OFF	
P65E	Supervised zones	NONE	31	
P66E	1E	Zone Supervision alarm to RESET o/p	OFF	32, 33
	2E	Zone Supervision alarm to STROBE	OFF	
	3E	Zone Supervision alarm to SONALERT	OFF	
	4E	Zone Supervision alarm to SIREN	OFF	
	5E	Enable WIRED ZONE supervision	OFF	
	6E	[not used]	OFF	
	7E	Zone Supervision speedup x 6	OFF	
	8E	Zone Supervision speedup x10	OFF	
P67E	Zone Supervision Time	24 (hours)	33	
P68E	1E	Double Press Radio Panic	OFF	34
	2E	Auto Re-Arm	OFF	
	3E	Long Radio Message	ON	
	4E	"OK/READY" Display	OFF	
	5E	Radio Arming "unsealed" warning	OFF	
	6E	24hr Zone Fire Siren sound	OFF	
	7E	Single Shot strobe on Arm by R/Key	OFF	
	8E	Quiet chirps on radio Arm/Disarm	OFF	
P69E	1E	Flash strobe on medical alarm	OFF	36, 37
	2E	[not used]	OFF	
	3E	Quiet Home Mode Siren	OFF	
	4E	6 beeps on Arming	OFF	
	5E	Home arm by radio key ON/OFF	OFF	
	6E	Disable Mains Fail Alarm	OFF	
	7E	Exit BEEPS - Full Arm	OFF	
	8E	Exit BEEPS - Home Mode	OFF	

OPTION	DESCRIPTION	DEFAULT	PAGE
P70E	TELEPHONE NO.1 Primary	NONE	38
P71E	Telephone No.2 Secondary	NONE	
P72E	ACCOUNT NO. 1	0000	39
P73E	Account No. 2	0000	
P74E	REPORT ZONE ALARMS	All zones	40
P75E* D8 & D16	1E Report DURESS alarms	OFF	41
	2E Report MEDICAL alarms	OFF	
	3E Report keypad & Keyswitch PANIC	ON	
	4E Report FIRE alarms	OFF	
	5E Report PANEL TAMPER alarms	ON	
	6E Report EXTERNAL TAMPER alarms	ON	
	7E Report KEYPAD TAMPER alarms	ON	
	8E Report EXIT FROM INSTALLER mode	OFF	
D8, P92E 1E* D16, P75E 9E*	Report RADIO TAMPER	ON	
D8, P92E 2E* D16, P75E 10E*	Report RADIO PANIC by User ID	ON	
D8, P92E 3E* D16, P75E 11E*	Report RADIO Low Battery by device	OFF	
D8, P92E 4E* D16, P75E 12E*	Report ZONE SUPERVISION FAIL	OFF	
D8, P92E 5E* D16, P75E 13E*	Report PANEL LOW BATTERY	ON	
D8, P92E 6E* D16, P75E 14E*	Report MAINS FAIL	ON	
P76E*	Report Zone Restorals	All on	40
P77E	Report Misc. Restorals	All on	41
P78E	Report Multiple Zone alarms	NONE	40
P79E	Account No.2 zones	NONE	40
P80E	Tel No. 3 for Test Calls	NONE	39
P81E	Tel No.4 Callback	NONE	
P82E	1E Send RESTORAL report immediately	OFF	41
	2E Send RESTORAL after siren time	OFF	
	3E Send RESTORAL after Disarm & seal	OFF	
	4E Send RESTORAL after Disarm always	ON	
P83E	TEST CALL Interval	84 (168hrs)	42
P84E	Time before NEXT TEST CALL	6 (12hrs)	
P86E	1E Disable Dialler	OFF	43, 44
	2E CONTACT ID FORMAT	ON	
	3E [not used]	OFF	
	4E Audible VOICE Format*	OFF	
	5E [not used]	OFF	
	6E Contact ID + VOICE Format	OFF	
P87E*	1E Split dial Primary/Secondary numbers	OFF	45
	2E Check for Dial Tone	ON	
	3E [not used]	OFF	
	4E 4 Dialling attempts	ON	
	5E Reduce level - dialling phone number	OFF	
	6E Reduce level - sending alarm message	OFF	
	7E Reduce level - connecting to modem	OFF	

* Note that P86E 4E affects various other options when it is enabled. See notes on page 44.

OPTION	DESCRIPTION	DEFAULT	PAGE
P88E*	1E Send AREA 1 OPEN/CLOSE REPORTS	OFF	46, 47
	2E Send AREA 2 Open/Close reports	OFF	
	3E Siren Chirp on Kiss-off	OFF	
	4E Flash Strobe on Kiss-off	OFF	
	5E Forced Opening report	ON	
	6E Delayed Closing Reports	OFF	
	7E Manual Exclude Reports	ON	
	8E Auto Exclude Reports	ON	
P89E*	1E ENABLE TEST CALLS	ON	48, 49
	2E Mains Report Delay (1 hour)	ON	
	3E Listen-In to Dialler	OFF	
	4E Swinger shutdown	ON	
	5E Line Fault Monitor	OFF	
	7E [not used]	OFF	
	P90E	1E Enable Remote Access	
2E Enable First Call Mode		OFF	
3E Enable Remote Arming		OFF	
4E Enable Remote Disarming		OFF	
5E Enable Remote AUX control		OFF	
6E Enable Remote Status reporting		OFF	
7E Enable Remote Event Report		OFF	
8E Enable Callback Mode		OFF	
P91E	Required rings to answer	1	52
P92E*	Report Misc. Alarms 9-14 (D8 only)	1,2,5,6 on	41
P93E*	Report Misc. Restorals 9-14 (D8 only)	All on	
P94E	"No Memory Warning" zones	none	52
P95E	CLEAR RADIO DEVICES		53
P96E	CLEAR MEMORY		
P97E	CLEAR PANEL OPTIONS (restore Factory Defaults)		
P98E	CLEAR User codes, Radio Keys, Access Cards		
P99E	Program the INSTALLER CODE	000000	53
P101E-P116E	PROGRAM RADIO DEVICES 1-8 or 1-16	none	73
P117E	1E Enable Output Expander	OFF	54, 55
	2E Expander Output Format A, B	OFF	
	3E Day Zone Follower	OFF	
	4E Output Exclude	OFF	
	5E Expander Output Format C	OFF	
	6E User Code Toggle or Pulse	OFF	
P118E	Output Expander zones	none	
P119E	Output Expander alarm zones	none	
P120E	1E Latched keyswitch input	OFF	56
	2E Home arm chirps by radio key	OFF	
	3E Radio Key AUX arms Home mode	OFF	
	4E Keyswitch DISARM ONLY	OFF	
	5E Keyswitch ARM ONLY	OFF	
	6E Smart Beeps (Brief Home & Day modes)	OFF	
	7E Entry Delay Extender	OFF	
	8E Area2 Disarm by Keyswitch Allowed	OFF	

OPTION	DESCRIPTION	DEFAULT	PAGE
P121E	1E Zone alarms to AUX1 (P58E selects zones)	ON	58
	2E Zone Supervision alarms to AUX1	OFF	
	3E Radio key Panic TOGGLE	OFF	
	4E Radio key Panic PULSE	OFF	
	7E Door Open Too Long (DOTL) alarm to AUX1	OFF	
	8E Reader [x] output to AUX1	OFF	
P122E	1E Zone alarms to AUX2 (P59E selects zones)	ON	60
	2E Zone Supervision alarms to AUX2	OFF	
	3E Radio key Aux Button TOGGLE	OFF	
	4E Radio key Aux Button PULSE	OFF	
	5E Telephone Line fault to AUX2	OFF	
	7E Door Open Too Long (DOTL) alarm to AUX2	OFF	
P123E	1E Zone Alarms to AUX3	OFF	62
	3E Enable AUX3 for AutoTime	OFF	
	4E Radio Key Panic Pulses AUX3	OFF	
	8E Reader [x] output to AUX3	OFF	
P124E	1E Zone Alarms to AUX4	OFF	64
	2E Enable Extension Sonalert	OFF	
	3E Enable AUX4 for AutoTime	OFF	
	4E Radio Key Aux Pulses AUX4	OFF	
	5E Enable AUX4 as Fail To Communicate o/p	OFF	
	8E Reader [x] output to AUX4	OFF	
P125E	Enable hardwired zones	All on	68
P126E	1E Enable Double key PANIC	ON	68
	2E Enable Double key FIRE	OFF	
	3E Enable Dbl key MEDICAL & Nav MEDICAL	OFF	
	4E Enable Entry Chime, DAY Mode	OFF	
	5E Enable Entry Chime, HOME Mode	OFF	
	8E Disable One Digit At A Time display	ON	
P129E	1E 0k EOL resistors	OFF	68
	2E 1k EOL resistors	OFF	
	3E 1.5k EOL resistors	OFF	
	4E 2.2k EOL resistors	ON	
	5E 3.3k EOL resistors	OFF	
	6E 3.9k EOL resistors	OFF	
	7E 4.7k EOL resistors	OFF	
	8E 5.6k EOL resistors	OFF	
	9E 6.8k EOL resistors	OFF	
	10E 8.2k EOL resistors	OFF	
	11E 10k EOL resistors	OFF	
	12E 12k EOL resistors	OFF	
	13E 22k EOL resistors	OFF	
P141E	1E Area 1 Armed to AUX1	OFF	59
	2E Area 2 Armed to AUX1	OFF	
	3E Home Armed to AUX1	OFF	
	4E Keypad toggle AUX1	OFF	
	5E Telephone remote control of AUX1	OFF	
	6E [not used]	OFF	
	7E [not used]	OFF	
	8E Pulse AUX1	OFF	

OPTION	DESCRIPTION	DEFAULT	PAGE
P142E	1E Area 1 Armed to AUX2	OFF	61
	2E Area 2 Armed to AUX2	OFF	
	3E Home Armed to AUX2	OFF	
	4E Keypad toggle AUX2	OFF	
	5E Telephone remote control of AUX2	OFF	
	6E [not used]	OFF	
	7E [not used]	OFF	
	8E Pulse AUX2	OFF	
P143E	1E Area 1 Armed to AUX3	OFF	63
	2E Area 2 Armed to AUX3	OFF	
	3E Home Armed to AUX3	OFF	
	4E Keypad toggle AUX3	OFF	
	5E Telephone remote control of AUX3	OFF	
	6E [not used]	OFF	
	7E [not used]	OFF	
	8E Pulse AUX3	OFF	
P144E	1E Area 1 Armed to AUX4	OFF	65
	2E Area 2 Armed to AUX4	OFF	
	3E Home Armed to AUX4	OFF	
	4E Keypad toggle AUX4	OFF	
	5E Telephone remote control of AUX4	OFF	
	6E [not used]	OFF	
	7E [not used]	OFF	
	8E Pulse AUX4	OFF	
P145E	AUX1 Timer (1-99 sec)	20 sec	59
P146E	AUX2 Timer (1-99 sec)	20 sec	61
P147E	AUX3 Timer (1-99 sec)	20 sec	63
P148E	AUX4 Timer (1-99 sec)	20 sec	65
P151E	4E Keypad toggle AUX5	OFF	66
	5E Telephone remote control of AUX5	OFF	
	7E Reader Output to AUX5	OFF	
	8E PULSE AUX5	OFF	
P152E	4E Keypad toggle AUX6	OFF	66
	5E Telephone remote control of AUX6	OFF	
	7E Reader Output to AUX6	OFF	
P153E	4E Keypad toggle AUX7	OFF	66
	5E Telephone remote control of AUX7	OFF	
	7E Reader Output to AUX7	OFF	
P154E	4E Keypad toggle AUX8	OFF	66
	5E Telephone remote control of AUX8	OFF	
	7E Reader Output to AUX8	OFF	
P155E	AUX5 timer	20 sec	67
P156E	AUX6 timer	20 sec	
P157E	AUX7 timer	20 sec	
P158E	AUX8 timer	20 sec	

OPTION	DESCRIPTION	DEFAULT	PAGE
P160E	Alarm Siren Volume	99	67
P161E	Fire Siren Volume	99	
P162E	Chirp Siren Volume	16	
P198E	1E Home	OFF	84
	2E Office	OFF	
	3E Work	OFF	
	4E Family 1	OFF	
	5E Family 2	OFF	
	6E Family 3	OFF	
	7E System 1	OFF	
	8E System 2	OFF	
	9E System 3	OFF	
	10E Ness Security System	OFF	
	11E Ness Corporation	ON	
P199E	Serial Output Options 1E-7E	All off	75

ACCESS CONTROL OPTIONS

OPTION	DESCRIPTION	DEFAULT	PAGE
P300E	DEFAULT ALL ACCESS CONTROL OPTIONS		76
P301E	1E Use reader addresses	OFF	77
	2E Arm with double read	ON	
	3E Arm with single read and pushbutton	OFF	
	4E Disarm with access card	ON	
	5E REX Input 1 (Zone 5 input)	OFF	
	6E REX Input 2 (Zone 6 input)	OFF	
	7E REX Input 3 (Zone 7 input)	OFF	
	8E Strobe Flash on Arm/Disarm by Reader	ON	
P303E	DOTL zones	none	78
P304E	DOTL time	20 sec	
P305E	1E DOTL output LATCHES	OFF	
	2E DOTL outputs to Output Expander	OFF	
	3E DOTL Timer in Minutes	OFF	
	4E DOTL Timer in Hours	OFF	
5E DOTL zone flashes on keypad	OFF		

U REAL TIME CLOCK options can be programmed in User Program Mode.

OPTION	DESCRIPTION	DEFAULT	PAGE
P340E	Real Time Clock set MINUTES	00 (00-59)	70
P341E	Real Time Clock set HOURS	00 (00-23)	
P342E	Real Time Clock set DAY	01 (01-31)	
P343E	Real Time Clock set MONTH	01 (01-12)	
P344E	Real Time Clock set YEAR	09 (00-63)	
P345E	Real Time Clock VIEW DAY OF WEEK	(Sun=1)	

OPTION	DESCRIPTION	DEFAULT	PAGE
AUX OUTPUTS			
P318E	1E Ultraprox Reader 1 to AUX1	OFF	80
	2E Ultraprox Reader 1 to AUX2	OFF	
	3E Ultraprox Reader 1 to AUX3	OFF	
	4E Ultraprox Reader 1 to AUX4	OFF	
	5E Ultraprox Reader 1 to AUX5	OFF	
	6E Ultraprox Reader 1 to AUX6	OFF	
	7E Ultraprox Reader 1 to AUX7	OFF	
	8E Ultraprox Reader 1 to AUX8	OFF	
P319E	Ultraprox Reader 1 output TIME	5 sec	
P328E	1E Ultraprox Reader 2 to AUX1	OFF	
	2E Ultraprox Reader 2 to AUX2	OFF	
	3E Ultraprox Reader 2 to AUX3	OFF	
	4E Ultraprox Reader 2 to AUX4	OFF	
	5E Ultraprox Reader 2 to AUX5	OFF	
	6E Ultraprox Reader 2 to AUX6	OFF	
	7E Ultraprox Reader 2 to AUX7	OFF	
	8E Ultraprox Reader 2 to AUX8	OFF	
P329E	Ultraprox Reader 2 output TIME	5 sec	
P338E	1E Ultraprox Reader 3 to AUX1	OFF	
	2E Ultraprox Reader 3 to AUX2	OFF	
	3E Ultraprox Reader 3 to AUX3	OFF	
	4E Ultraprox Reader 3 to AUX4	OFF	
	5E Ultraprox Reader 3 to AUX5	OFF	
	6E Ultraprox Reader 3 to AUX6	OFF	
	7E Ultraprox Reader 3 to AUX7	OFF	
	8E Ultraprox Reader 3 to AUX8	OFF	
P339E	Ultraprox Reader3 output TIME	5 sec	

OPTION	DESCRIPTION	Default
AutoTimer 1		
P350E	Minutes 0-59	
P351E	Hours 0-23	
P352E	Days (1=Sunday)	
P353E	1E AREA 1 arm	
	2E AREA 2 arm	
	3E HOME arm	
	4E Code Enable	
	5E Code Disable	
	6E KEYPAD Beeps	
	7E RESET O/P Beeps	
	8E Extend AutoTIME	
P354E	1E AREA 1 disarm	
	2E AREA 2 disarm	
	3E HOME disarm	
	4E Uses AUX5&6 not AUX1&2	
	5E AUX1 TOGGLE	
	6E AUX1 PULSE	
	7E AUX2 TOGGLE	
	8E AUX2 PULSE	

OPTION	DESCRIPTION	Default
AutoTimer 4		
P365E	Minutes 0-59	
P366E	Hours 0-23	
P367E	Days (1=Sunday)	
P368E	1E AREA 1 arm	
	2E AREA 2 arm	
	3E HOME arm	
	4E Code Enable	
	5E Code Disable	
	6E KEYPAD Beeps	
	7E RESET O/P Beeps	
	8E Extend AutoTIME	
P369E	1E AREA 1 disarm	
	2E AREA 2 disarm	
	3E HOME disarm	
	4E Uses AUX5&6 not AUX1&2	
	5E AUX1 TOGGLE	
	6E AUX1 PULSE	
	7E AUX2 TOGGLE	
	8E AUX2 PULSE	

OPTION	DESCRIPTION	Default
AutoTimer 7		
P380E	Minutes 0-59	
P381E	Hours 0-23	
P382E	Days (1=Sunday)	
P383E	1E AREA 1 arm	
	2E AREA 2 arm	
	3E BRIEF DAY MODE arm	
	4E Code Enable	
	5E Code Disable	
	6E KEYPAD Beeps	
	7E RESET O/P Beeps	
	8E Extend AutoTIME	
P384E	1E AREA 1 disarm	
	2E AREA 2 disarm	
	3E BRIEF DAY MODE disarm	
	4E Uses AUX7&8 not AUX3&4	
	5E AUX3 TOGGLE	
	6E AUX3 PULSE	
	7E AUX4 TOGGLE	
	8E AUX4 PULSE	

OPTION	DESCRIPTION	Default
AutoTimer 2		
P355E	Minutes 0-59	
P356E	Hours 0-23	
P357E	Days (1=Sunday)	
P358E	1E AREA 1 arm	
	2E AREA 2 arm	
	3E HOME arm	
	4E Code Enable	
	5E Code Disable	
	6E KEYPAD Beeps	
	7E RESET O/P Beeps	
	8E Extend AutoTIME	
P359E	1E AREA 1 disarm	
	2E AREA 2 disarm	
	3E HOME disarm	
	4E Uses AUX5&6 not AUX1&2	
	5E AUX1 TOGGLE	
	6E AUX1 PULSE	
	7E AUX2 TOGGLE	
	8E AUX2 PULSE	

OPTION	DESCRIPTION	Default
AutoTimer 5		
P370E	Minutes 0-59	
P371E	Hours 0-23	
P372E	Days (1=Sunday)	
P373E	1E AREA 1 arm	
	2E AREA 2 arm	
	3E HOME arm	
	4E Code Enable	
	5E Code Disable	
	6E KEYPAD Beeps	
	7E RESET O/P Beeps	
	8E Extend AutoTIME	
P374E	1E AREA 1 disarm	
	2E AREA 2 disarm	
	3E HOME disarm	
	4E Uses AUX7&8 not AUX3&4	
	5E AUX3 TOGGLE	
	6E AUX3 PULSE	
	7E AUX4 TOGGLE	
	8E AUX4 PULSE	

OPTION	DESCRIPTION	Default
AutoTimer 8		
P385E	Minutes 0-59	
P386E	Hours 0-23	
P387E	Days (1=Sunday)	
P388E	1E AREA 1 arm	
	2E AREA 2 arm	
	3E BRIEF DAY MODE arm	
	4E Code Enable	
	5E Code Disable	
	6E KEYPAD Beeps	
	7E RESET O/P Beeps	
	8E Extend AutoTIME	
P389E	1E AREA 1 disarm	
	2E AREA 2 disarm	
	3E BRIEF DAY MODE disarm	
	4E Uses AUX7&8 not AUX3&4	
	5E AUX3 TOGGLE	
	6E AUX3 PULSE	
	7E AUX4 TOGGLE	
	8E AUX4 PULSE	

OPTION	DESCRIPTION	Default
AutoTimer 3		
P360E	Minutes 0-59	
P361E	Hours 0-23	
P362E	Days (1=Sunday)	
P363E	1E AREA 1 arm	
	2E AREA 2 arm	
	3E HOME arm	
	4E Code Enable	
	5E Code Disable	
	6E KEYPAD Beeps	
	7E RESET O/P Beeps	
	8E Extend AutoTIME	
P364E	1E AREA 1 disarm	
	2E AREA 2 disarm	
	3E HOME disarm	
	4E Uses AUX5&6 not AUX1&2	
	5E AUX1 TOGGLE	
	6E AUX1 PULSE	
	7E AUX2 TOGGLE	
	8E AUX2 PULSE	

OPTION	DESCRIPTION	Default
AutoTimer 6		
P375E	Minutes 0-59	
P376E	Hours 0-23	
P377E	Days (1=Sunday)	
P378E	1E AREA 1 arm	
	2E AREA 2 arm	
	3E HOME arm	
	4E Code Enable	
	5E Code Disable	
	6E KEYPAD Beeps	
	7E RESET O/P Beeps	
	8E Extend AutoTIME	
P379E	1E AREA 1 disarm	
	2E AREA 2 disarm	
	3E HOME disarm	
	4E Uses AUX7&8 not AUX3&4	
	5E AUX3 TOGGLE	
	6E AUX3 PULSE	
	7E AUX4 TOGGLE	
	8E AUX4 PULSE	

AUTOTIMER RELATED OPTIONS

OPTION	DESCRIPTION	Default
P390E	AutoTime warning (1-99 min)	00
P392E	1E AutoTime codes Option	OFF
P121E	3E Enable AUX1 for AutoTimers	OFF
P122E	3E Enable AUX2 for AutoTimers	OFF
P123E	3E Enable AUX3 for AutoTimers	OFF
P124E	3E Enable AUX4 for AutoTimers	OFF
P145E	AUX1 Pulse Time (1-99 sec)	20 sec
P146E	AUX2 Pulse Time (1-99 sec)	20 sec
P147E	AUX3 Pulse Time (1-99 sec)	20 sec
P148E	AUX4 Pulse Time (1-99 sec)	20 sec

See pages 68, 69 for descriptions of AutoTimer related options.

CONTROL PANEL PACKING LIST

- 1 D8XD or D16XD Main board
- 1 Housing
- 1 Power supply (Australia only)
- 1 12V 7Ah battery (optional)
- 1 Dialler telephone lead
- 1 User manual
- 1 Installer manual
- 9 or 17 End Of Line resistors 2.2k (D8x/D16x)
- 1 Lead assembly for battery
- 1 Lead assembly for internal tamper
- 2 Housing cover screws
- 4 Circuit board standoffs

Keypads are optional

SPECIFICATIONS

Plastic housing dimensions	235w x 300h x 90d mm.
Power requirement	17VAC or 20VDC
Quiescent current draw	80mA with 1 keypad.
Rechargeable battery	12 volt 7.0 Amp/hour Sealed Lead Acid.
Battery charging current	350mA maximum, current limited.
Dynamic battery test	Backup battery is tested under load, hourly and on arming.
Fuses	2 Amp auto resetting / Siren output & Reset output. 500mA auto resetting / 12 volt auxiliary outputs. 200 mA auto resetting / strobe output.
INPUTS / OUTPUTS	
Zones	8 or 16 zone inputs. 2 x 24hr tamper inputs.
End of line resistor	Default 2200 Ohms (2.2k). Other values programmable.
Maximum keypads	Maximum 3x mixed keypads or 4x Navigator keypads per system
LISTEN header	Output for audio alerts and dialler listen-in.
RECEIVER header	Connection for the Ness Radio Interface.
AUX header	Multi-pin connector provides outputs Aux1, Aux2, Aux3, Aux4, 12V DC
SERIAL header	Serial data port for data input/output and direct connect programming using NessComms™ software.
READER header	Multi-pin port for connecting up to 3 Ness proximity access card readers.
Siren	On board siren driver with timed output . Maximum 3 x 8 Ohm horn speakers.
Strobe	12V DC timed output. Maximum 2 x 1 Watt strobe lights.
Reset	12V DC timed output. Maximum 3 x 12V piezo screamers.
Equipment power output	13.8V DC output for powering detectors and other equipment. Maximum 500mA.

APPROVALS

EMC COMPLIANCE

EN 50130-4:1996 Part 4: Electromagnetic compatibility. Electrostatic Discharge, Radiated RF Immunity, Electrical Fast Transient/burst. Surge Immunity, Conducted RF Immunity, Voltage Dips and Interruptions, Mains Supply Variations.

AS/NZ CISPR 22:2002- Class B, Electromagnetic Radiation, Terminal Disturbance Voltage.

EN61000-6-3:2001, Harmonic Current Emissions, Voltage fluctuations and Flicker.

TELECOM

TBR21, EU. PTC200, NEW ZEALAND TELECOM . AS ACIF S002, AUSTRALIA

SAFETY

EN60950:2000 inc Country Deviations, Safety of Information Technology Equipment

AS/NZ3260-1993 incl. AMDTS 1,2,3 &4. TS001-1997 ACA Australian Communications Authority



RELEASE NOTES

Rev 2.5 Mar 2023

p4 Added heading 'Landline Dialler'
Deleted reference to remote programming.
p5, NessComms, deleted reference to modem.
Added 'NessComms operates by direct connect to the control panel's serial port'
p10 Keypads operation table. All new content modified from XCEL manuals
p10 Memory Mode, LINE changed to CELL
p49 refer to LINE & CELL icons
p83 changed 'digital dialler' to 'landline dialler'
p14, Emphasis on "User Codes must not start with Zero"

Rev 2.4 Apr 2020

p82, updated instructions for weigand reader addressing
p85, added: P90E 1E must be enabled for Telephone Remote Control to work.

Rev 2.3 Aug 2019

Output expander 'out of stock notice' deleted (106-011 is available again).
P10, added Keypad Adjustments section

Rev 2.2 July 2019

P64, P124E typo. Radio AUX button not Panic button

Rev 2.1 Mar 2019

Added note: Output Expanders are no longer manufactured as of January 2019.
The information in this manual is provided for reference and re-programming of existing devices."

Rev 2.0 Apr 2018

P75, Added P199E 7E, Send Test ASCII data option

Rev 1.9 Jan 2017

P24, P68, Note, Added keyswitch panic to wiring diagram
P44, New notes regarding Related Options when P86E 4E Audible Voice monitoring is enabled.
P40, 41, 45, 46, 47 notes regarding options effected by P86E 4E

Rev 1.8 Nov 2016

P24, P68, Note, The keyswitch input (if enabled) always uses a 2K2 resistor regardless of the global EOL resistor value set by P129E.
P34, P68E 3E note that some radio devices may require this option to be off.
P73, P74 added instructions for radio programming via Navigator keypad.

Rev 1.7 Aug 2016

P15 programming notes to suit both LCD and Navigator keypads

Rev 1.6 Mar 2016

Connection diagram caters for dual voltage models, 17VAC & 20VDC

Rev 1.5 Nov 2015

P97E Clear Panel Options also defaults radio devices.
P94E No Memory warning zones. The option applies only to zones 1-8 (both D8x and D16x)

V8.4 Sep 2015

Manual 890-017 Rev 1.4

Changed operation of P117E 6E
Wiring diagram caters for 15VDC and Dual input (17VAC/20VDC) boards.
Added wiring diagrams for sensors, page 9
Bug fix in V8.0 P198E, P199E had been shifted to P197E, P198E
Bug fix V8.3 Day of Week Saturday with Autotimers display on Navigator fixed.

V8 Feb 2015

New manual 890-017 Rev 1.0

MAJOR VERSION RELEASE

- New PCB layout
- Now with 8 AUX outputs (1-4 on relay board or 1-8 on output expander/s)
- Added modem chip, use any modem in 300baud mode
- Voice alarms and voice prompts using a preset voice message library
- Real time clock onboard
- Serial port different connector, now 4 pin
- Listen-in header changed
- Required power supply is now 15VDC for efficiency (Do not use 17VAC)
- Tamper/Prog link moved to corner of pcb
- Many new program options including
 - P117E 5E, used in combination with P117E 2E gives three sets of output configurations for output expander/s.
 - P151E-P154E, 4E-8E AUX5-AUX8 output options
 - P155E-P158E AUX5-AUX8 Timers
 - P318E, P328E, P338E, 5E-8E Reader options for AUX-5-8
 - P117E 6E User Code 13-15 Toggle or Pulse
 - P160E Alarm Siren Level
 - P161E Fire Siren Level
 - P162E Chirp Siren Level
 - P305E 3E DOTL Timer in Minutes
 - P305E 4E DOTL Timer in Hours
 - P354E-P389E Autotimer using AUX5-AUX8
 - P123E 1E Zone Alarms to Aux3
 - P124E 1E Zone Alarms to Aux4
 - P123E 4E Radio Key Panic Pulses AUX3
 - P124E 4E Radio Key Panic Pulses AUX4
 - P87E 5E Reduce tone output when dialling telephone number

P87E 6E Reduce tone output when sending alarm message
P87E 7E Reduce tone output when connecting to modem
P198E System Name

V7.8.6 Oct 2014

Changes to manual only. Page 67, Enable/disable user codes by AutoTime applies to keypad codes only, not radio keys or prox fobs.

V7.8.5 Mar 2014

Changes to manual only. Page 80, digit zero on remote phone tells panel that commands follow.

V7.8.4 Feb 2014

Changes to manual only. Page 53, P96E Note: This option clears only the 20 event memory as read by KPX and LCD keypads. Ness Navigator touch screen keypad's 80 event memory is not affected.
P54, improved description of User Code operation of outputs on Expander 2.

V7.8.3 May 2013

Changes to manual only. Page 54, corrected reference to J5 connector - now refers to AUX connector.

V7.8.2 Apr 2013

Changes to manual only. Added RCM mark. Internal clock timing warning page 67.

V7.8.1 Jan 2013

Changes to manual only. Removed reference to RK3 radio key.

V7.8 April 2012

1. Allow * & # on serial ascii input.
 2. Add version & model to status list
 3. P68E 3E Radio 56bit, now defaulted ON
- Added instructions for programming via NessPD

V7.7 January 2012

Fixed Leap year issues.

V7.6 November 2011

Fixed Day Mode, triggering Aux2 did not timeout after 2sec but followed zone state.
Fixed Real Time Clock speed up. Hardware change.

V7.5 September 2011

Fixed fire siren turnoff. It was changing to standard siren instead of switching off.
Allow NAVIGATOR v2 keypads to display time stamped event memory. Up to 80 events are displayed with TIME, DATE and EVENT. ZONE NAMES and USER NAMES are also displayed. The NAVIGATOR allows the user to go back and forth through the event memory.

V7.4 April 2011

1. Added Program Option P69E 1E: Flash Strobe on Medical alert.
2. Fixed AUX2 turning off even though P121E 6E was selected.

V7.3 July 2010

1. Radio Processing. The time of an internal wait timer has been reduced so that successive events are processed faster to prevent possible missed messages.
2. Aux1 pulsing Aux3 and Aux2 pulsing Aux4 issue fixed. The NAVIGATOR shows the AUX states, which has made the effect visible.
3. Ascii messages now include D8x output results. New messages are added to indicate the states of the D8x outputs - including the AUX, Siren, Strobe, Reset etc.
These new messages will allow the NAVIGATOR AUX 1 to 4 controls to also control C-Bus outputs, when used with the new miniCentral C-Bus unit.
4. Watchdog Timer. The watchdog timer operation has been changed during up/download via modem. An Eeprom with slow programming times could initiate the watchdog - stopping up/download from working

V7.2 May 2010

Allow LED keypads to operate correctly.
KEYPADS can be used in the following combinations:

- LED & KPX (or SATURN).
- KPX & NAVIGATOR.
- LED & NAVIGATOR keypads cannot be used on the same installation

V7.1 April 2010

1. Extra keypad signal added to allow NAVIGATOR to show RSSI of pendants and detectors in program modes.
2. Minor database number update allows older NESSCOMS versions to give 'a need to update' warning.

NOTES

INSTALLATION RECORD



- NESS D8 ALARM CONTROL PANEL
 NESS D16 ALARM CONTROL PANEL

- P26E** ENTRY DELAY TIME 1
P27E ENTRY DELAY TIME 2
P28E EXIT DELAY TIME
P29E SIREN RESET TIME

DATE PURCHASED:	DATE INSTALLED:
INSTALLATION COMPANY:	
TELEPHONE:	
MONITORING COMPANY:	
TELEPHONE:	

<input type="text"/>	Seconds
<input type="text"/>	Seconds
<input type="text"/>	Seconds
<input type="text"/>	Minutes

ZONE ASSIGNMENT

- P41E** ENTRY DELAY 1
P43E ENTRY DELAY 2
P42E HANDOVER
P40E INSTANT
P45E AREA 1
P46E AREA 2
P51E MONITOR
P52E 24 HOUR
P54E RESET OUTPUT
P55E STROBE OUTPUT
P56E SONALERT OUTPUT
P57E SIREN OUTPUT
P74E Report (dialler)

ZONES	DEVICE TYPE	PIR, Reed switch, etc	DESCRIPTION	Entrance, bedroom1, etc	P41E	P43E	P42E	P40E	P45E	P46E	P51E	P52E	P54E	P55E	P56E	P57E	P74E
D8 & D16	1																
	2																
	3																
	4																
	5																
	6																
	7																
	8																
D16	9																
	10																
	11																
	12																
	13																
	14																
	15																
	16																

USER CODE	OPTION No	Extra Options Assigned E.g. Radio Code, Arm Only, etc.
1 <small>Master Code</small>	P201E	
2	P202E	
3	P203E	
4	P204E	
5	P205E	
6	P206E	
7	P207E	
8	P208E	
9	P209E	
10	P210E	
11	P211E	
12	P212E	
13	P213E	
14	P214E	
15	P215E	
16	P216E	
17	P217E	
18	P218E	
19	P219E	

USER CODE	OPTION No	Extra Options Assigned E.g. Radio Code, Arm Only, etc.
20	P220E	
21	P221E	
22	P222E	
23	P223E	
24	P224E	
25	P225E	
26	P226E	
27	P227E	
28	P228E	
29	P229E	
30	P230E	
31	P231E	
32	P232E	
33	P233E	
34	P234E	
35	P235E	
36	P236E	
37	P237E	
38	P238E	

USER CODE	OPTION No	Extra Options Assigned E.g. Radio Code, Arm Only, etc.
39	P239E	
40	P240E	
41	P241E	
42	P242E	
43	P243E	
44	P244E	
45	P245E	
46	P246E	
47	P247E	
48	P248E	
49	P249E	
50	P250E	
51	P251E	
52	P252E	
53	P253E	
54	P254E	
55	P255E	
56	P256E	

